

Portastampo serie X 196 x 296

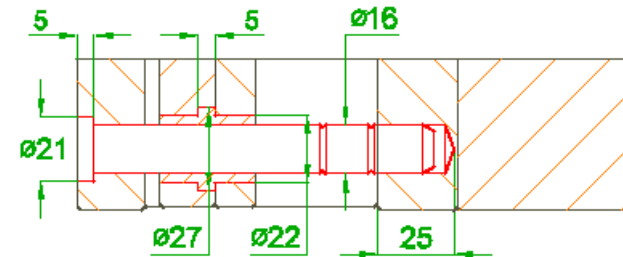

Portastampo serie X 196 x 346

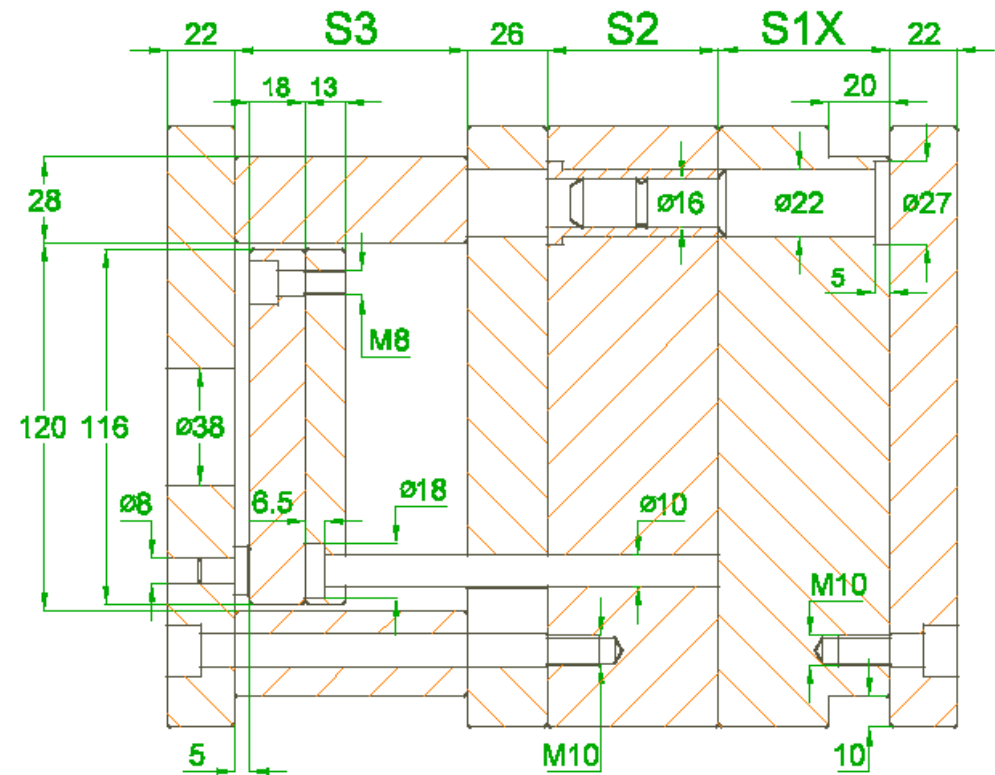
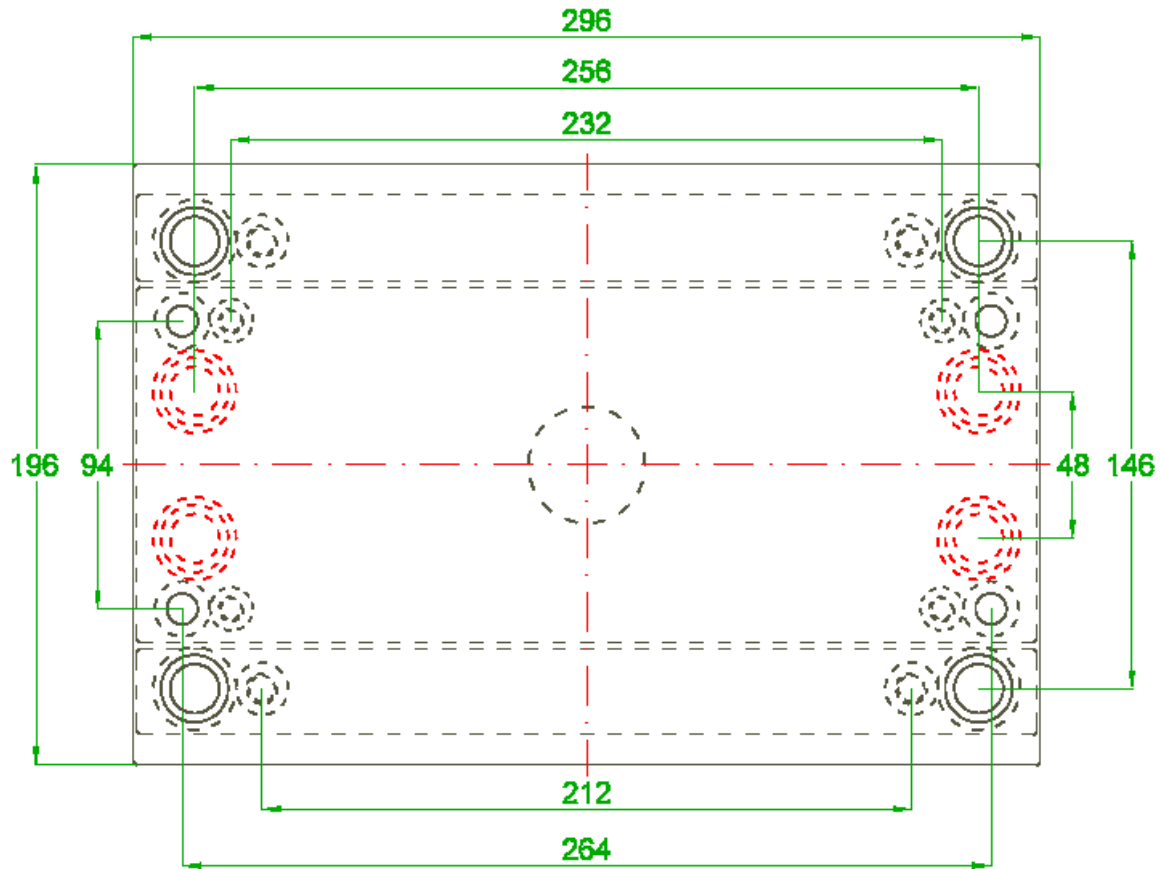
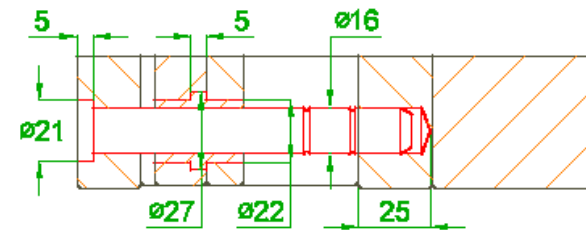
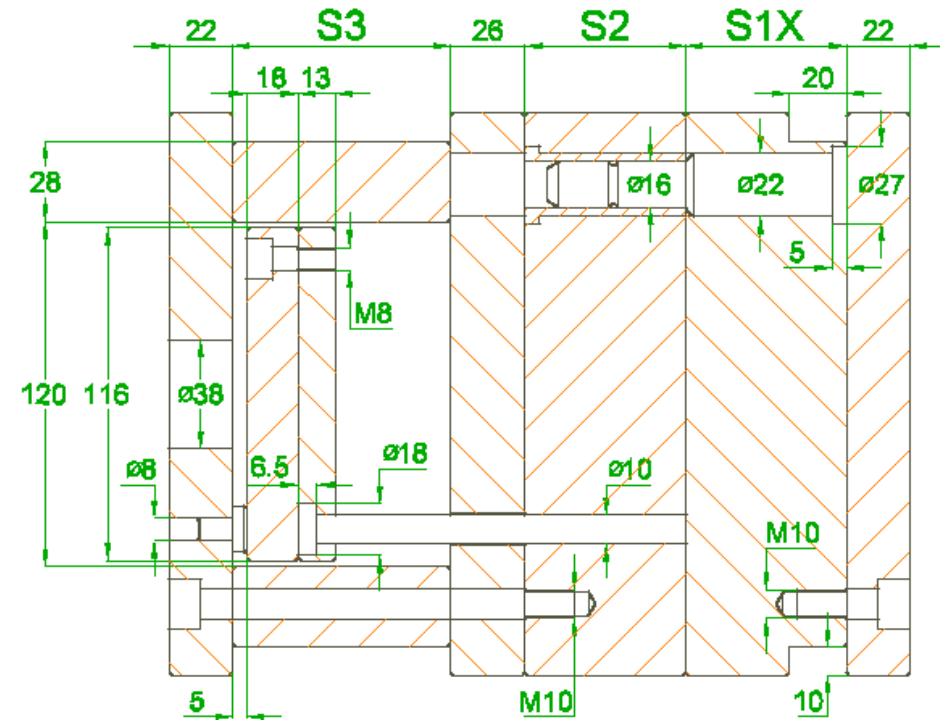
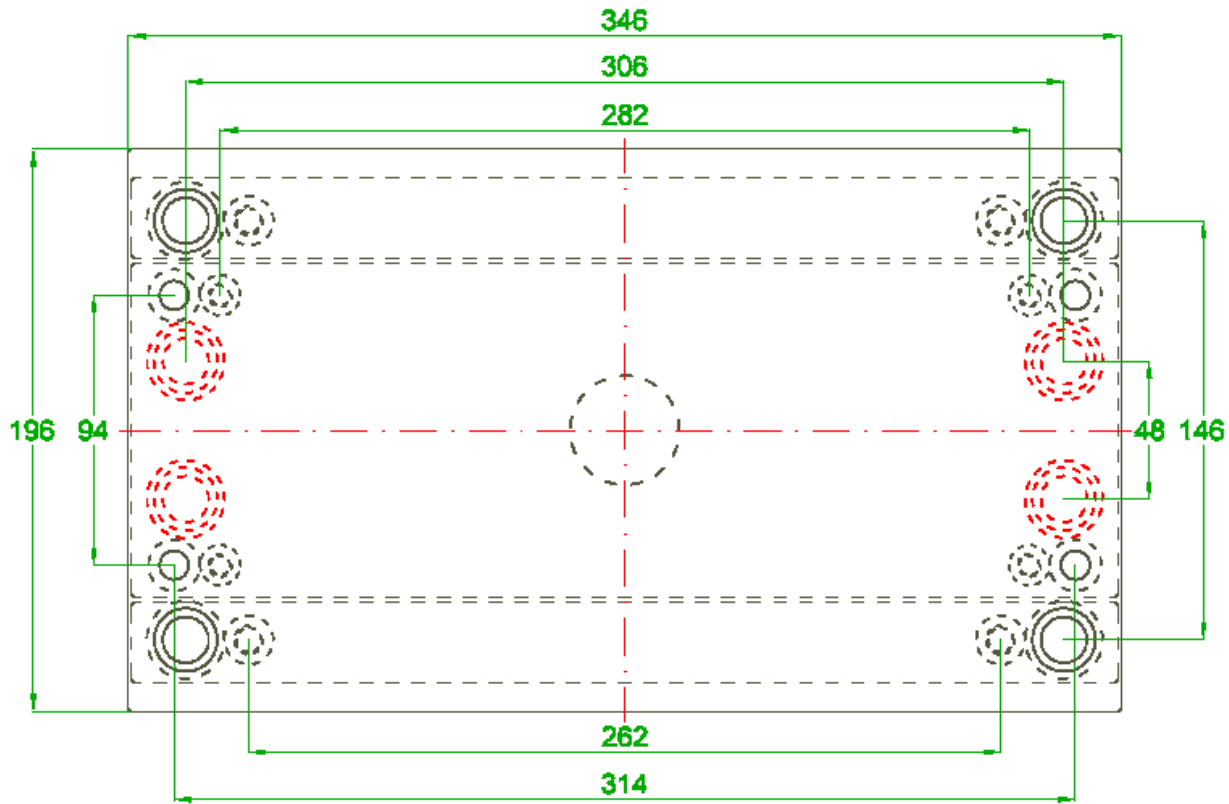

Portastampo serie X 246 x 346

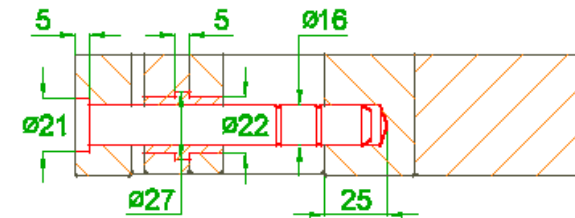
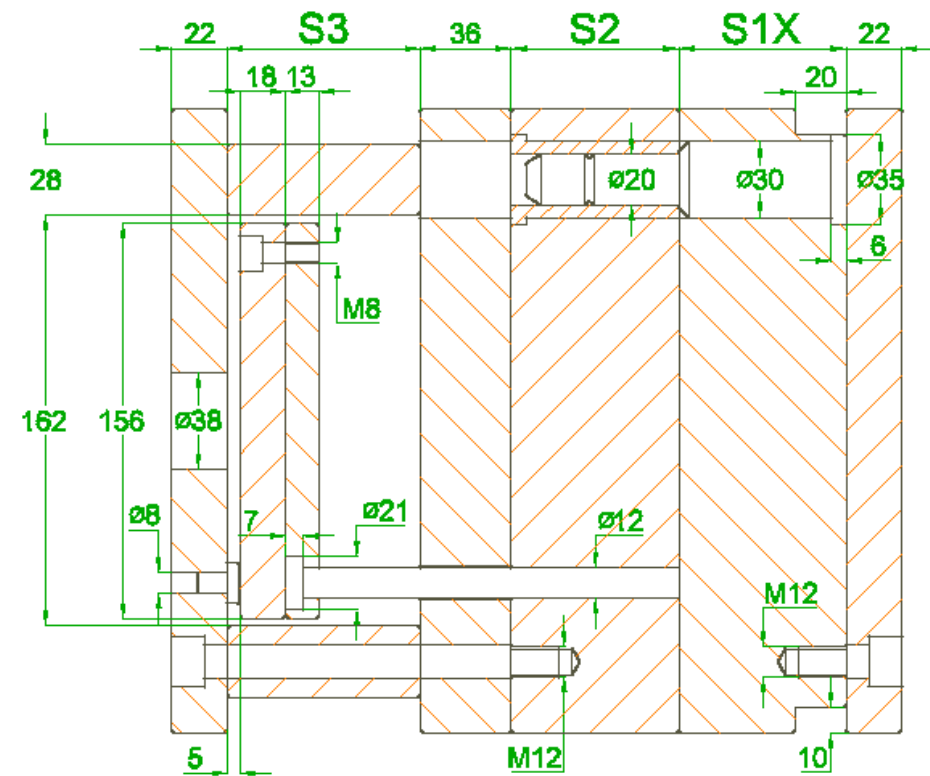
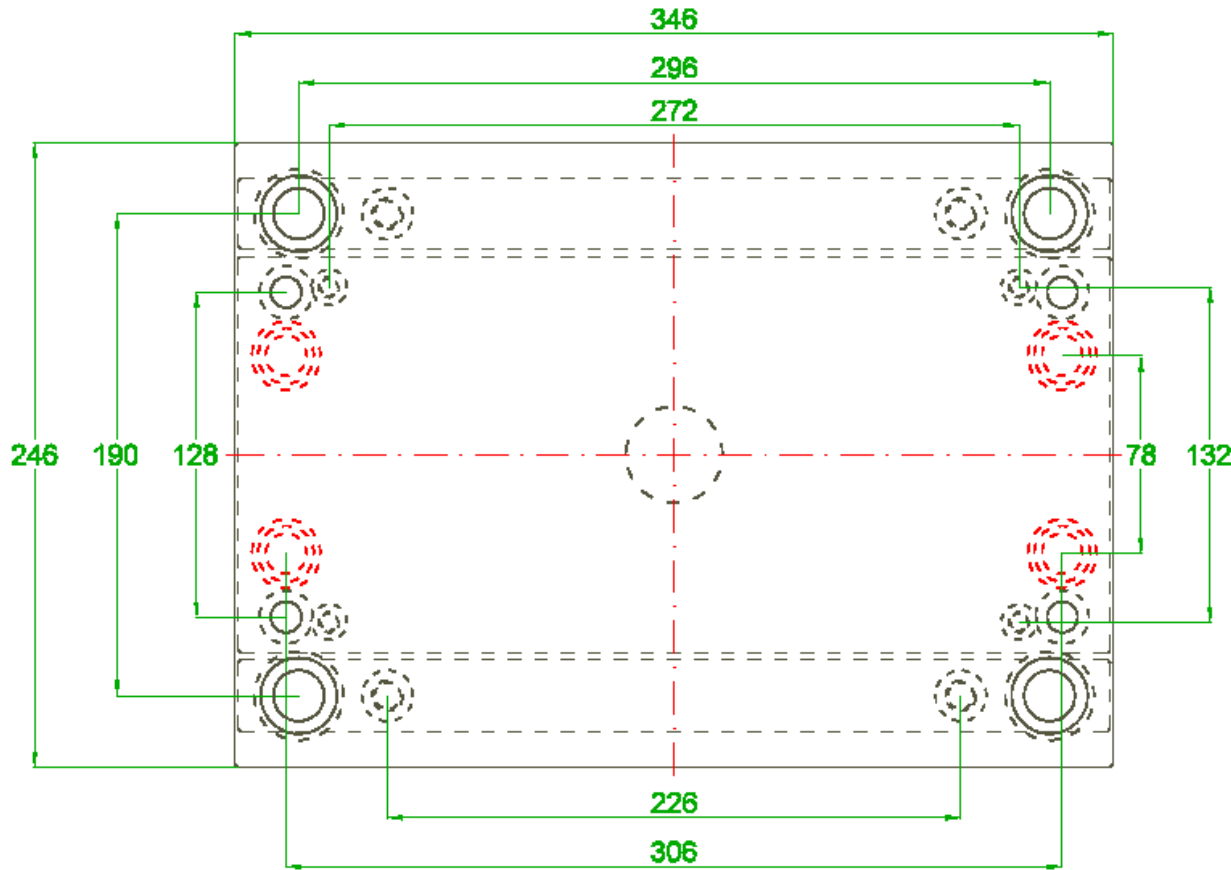

Portastampo serie X 296 x 296

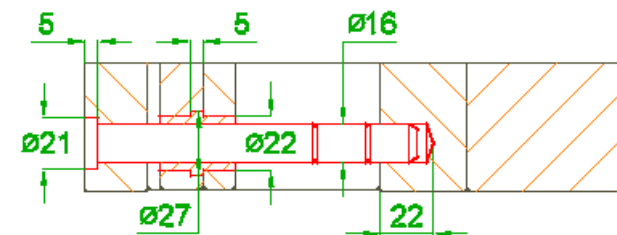
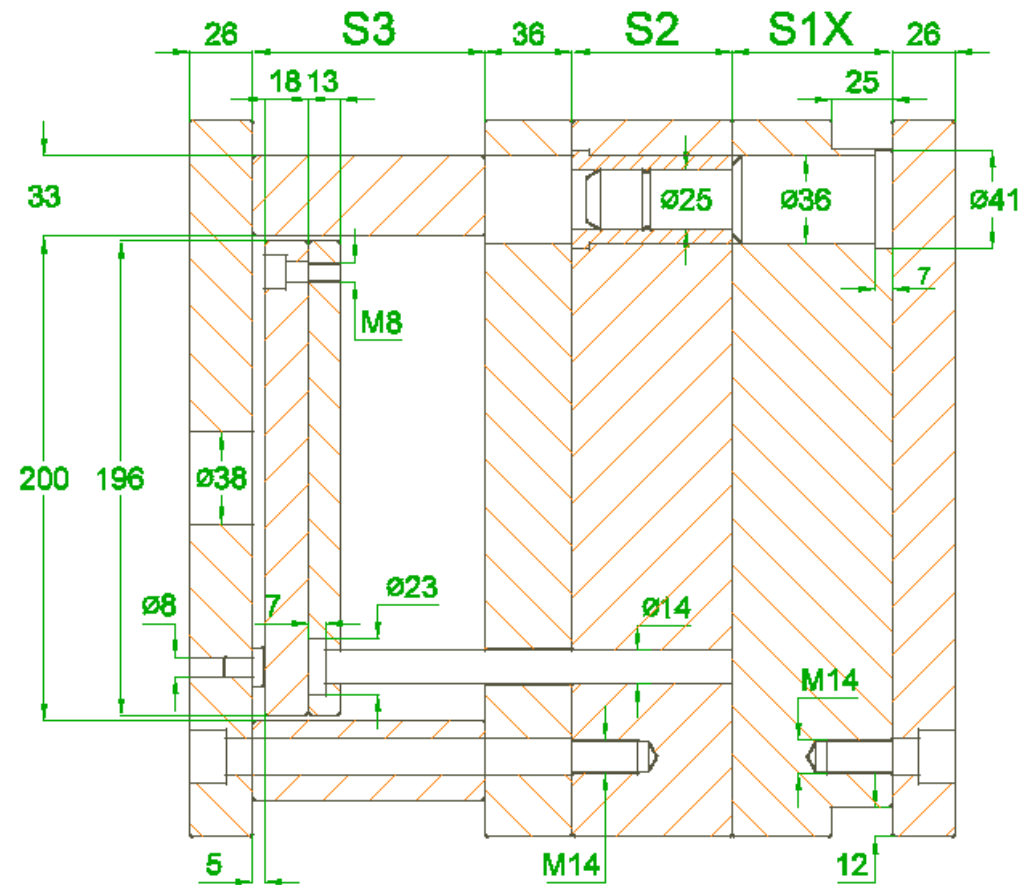
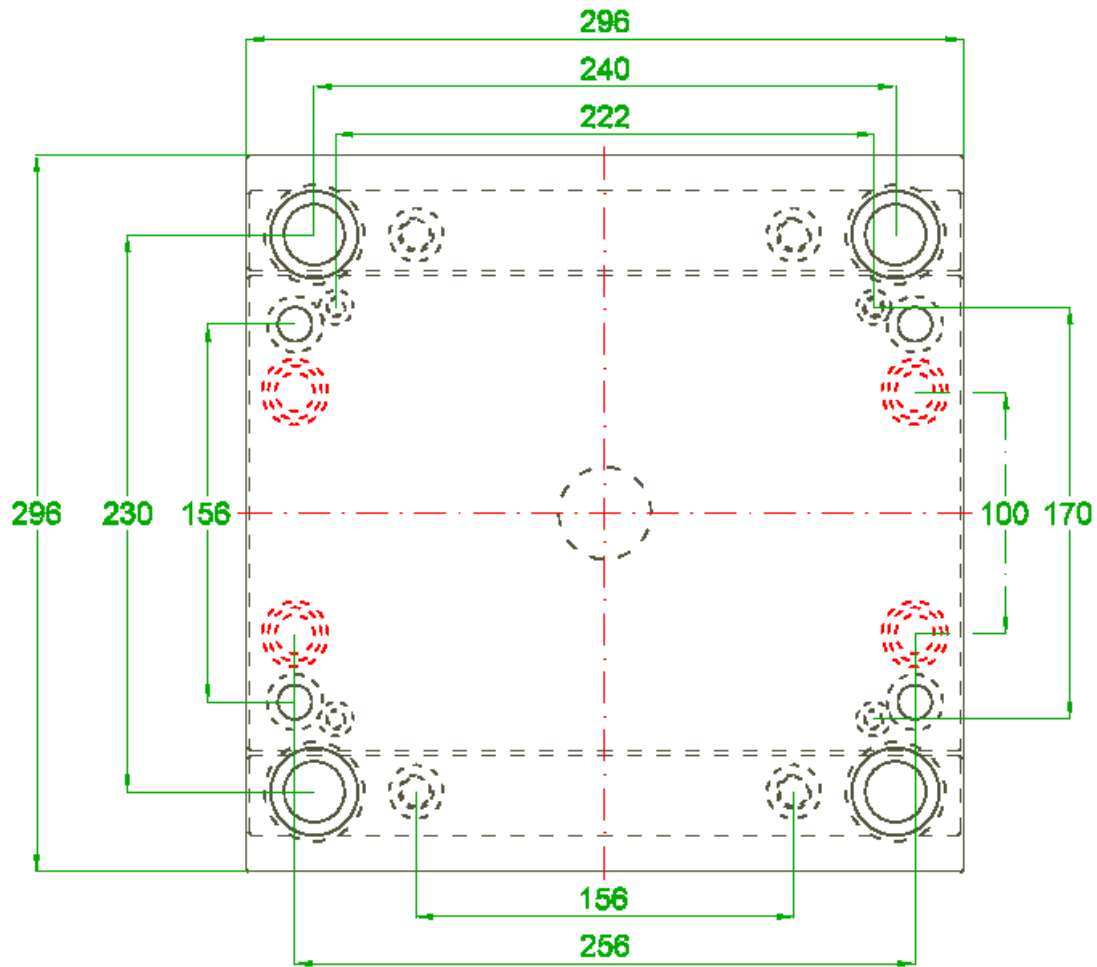

Portastampo serie X 296 x 446

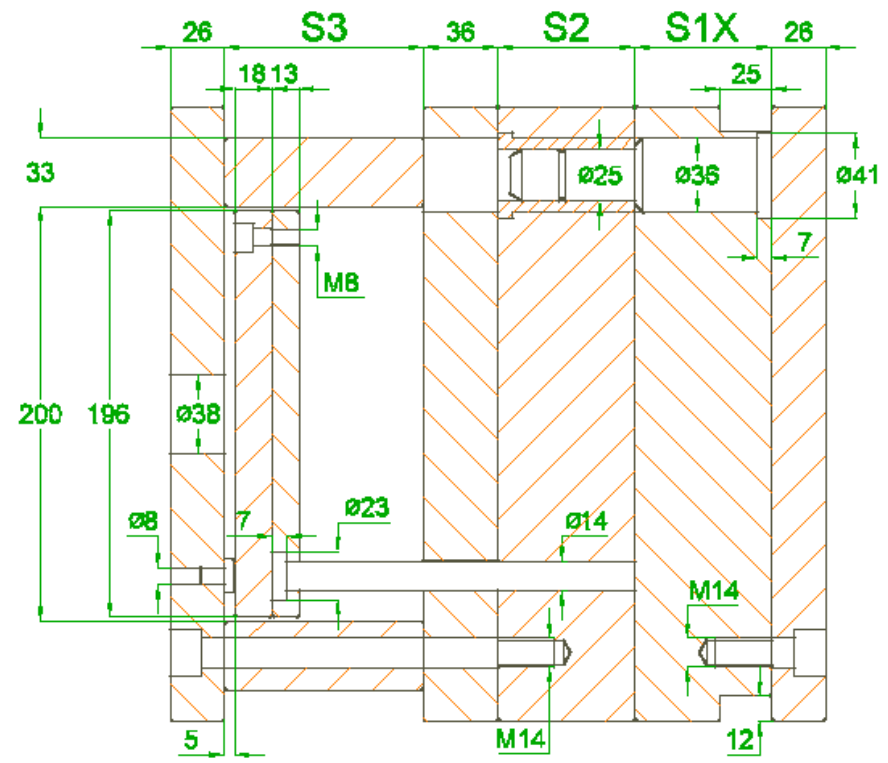
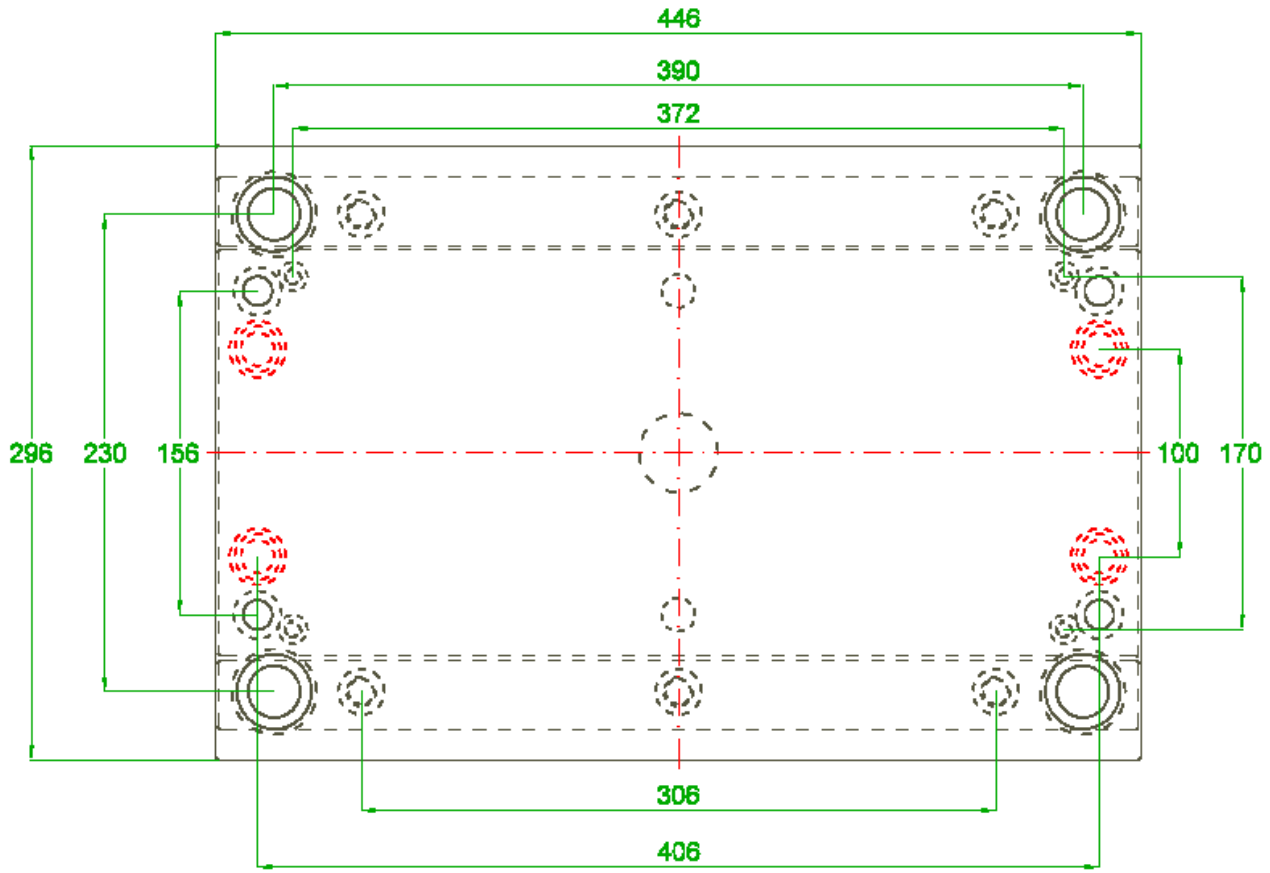

Portastampo serie X 346 x 346

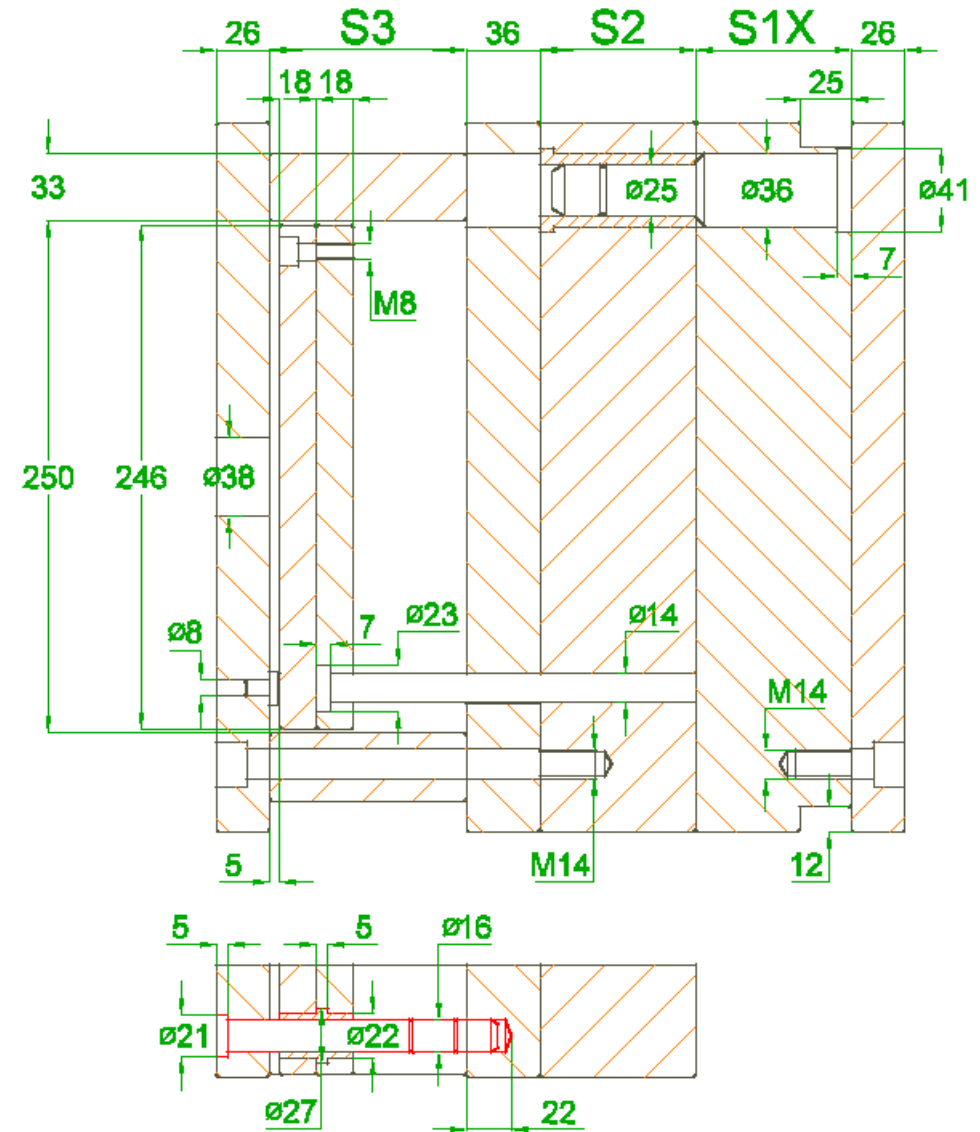
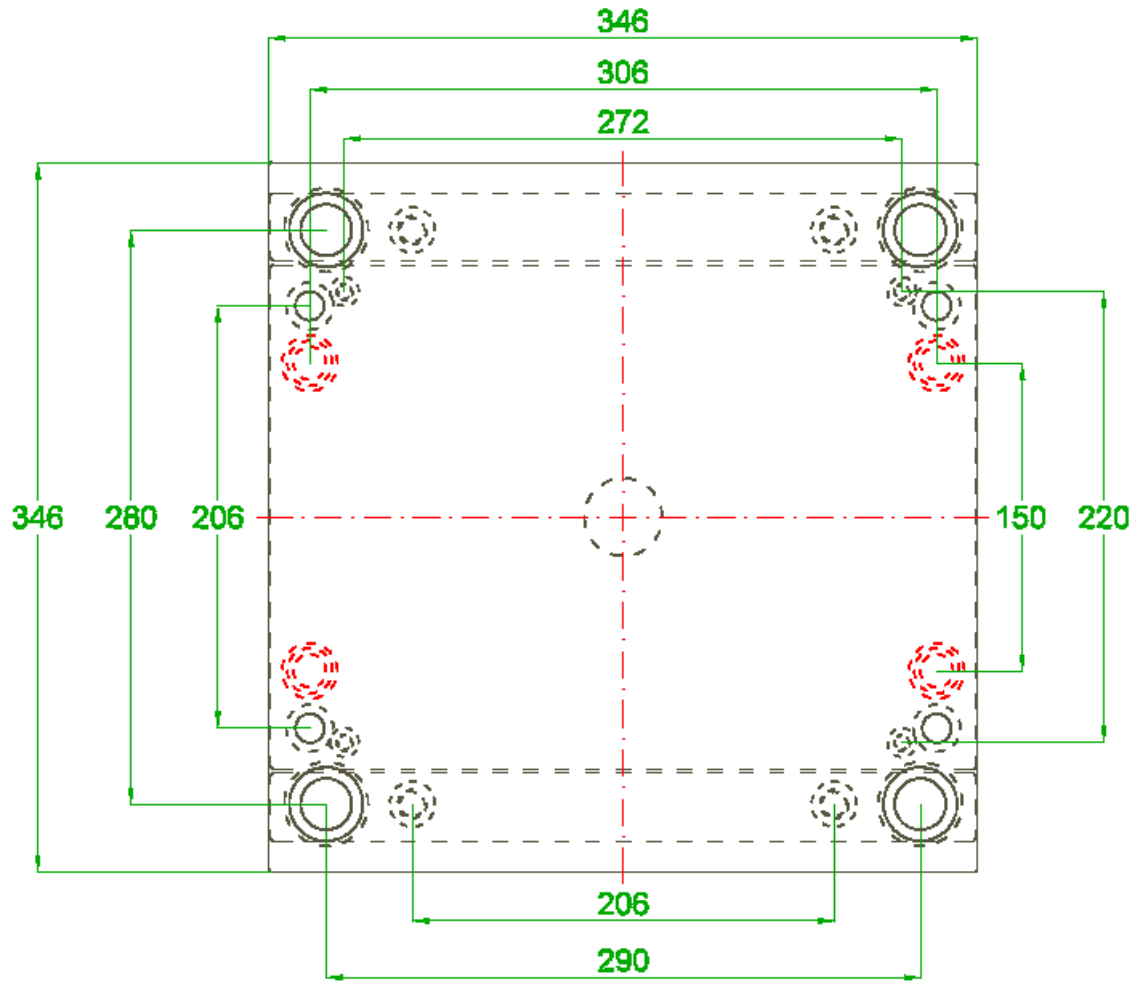

Portastampo serie X 346 x 396

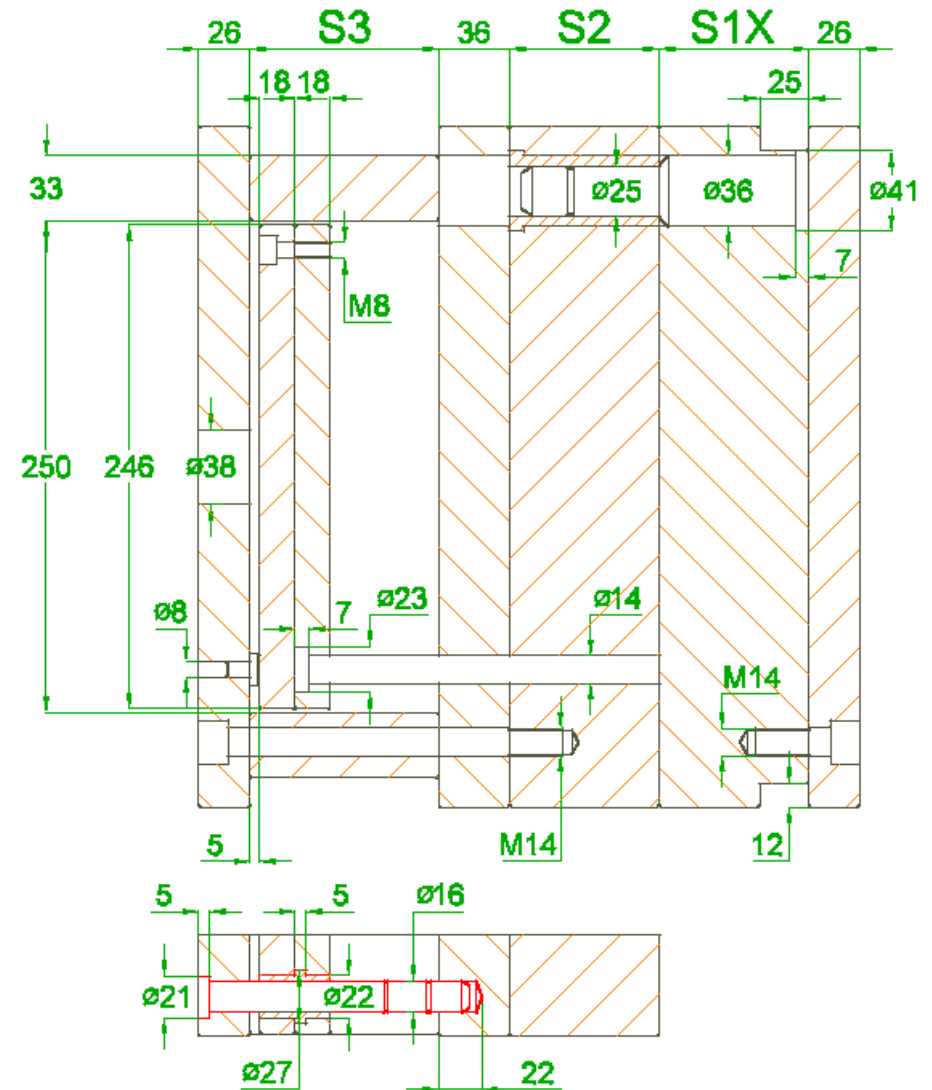
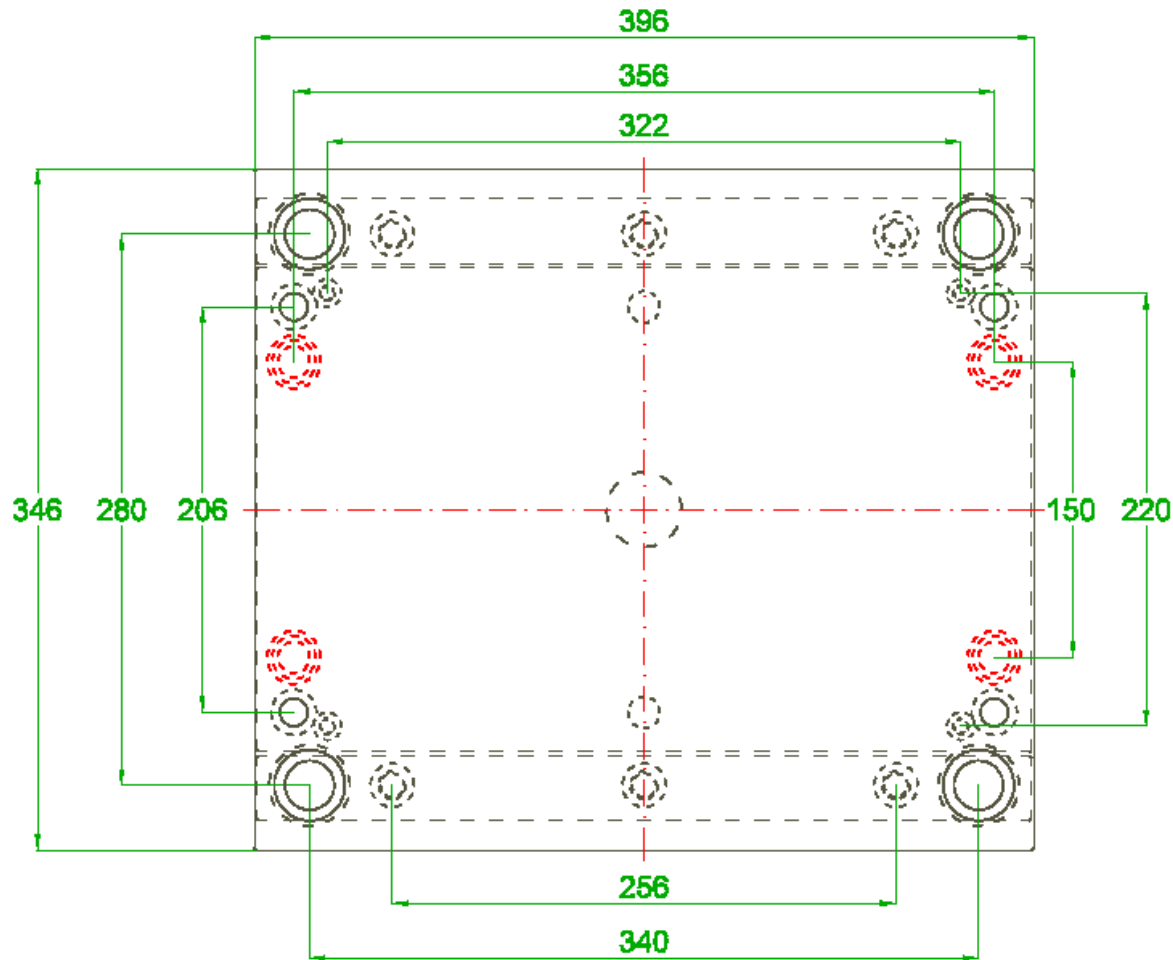

Portastampo serie X 346 x 446

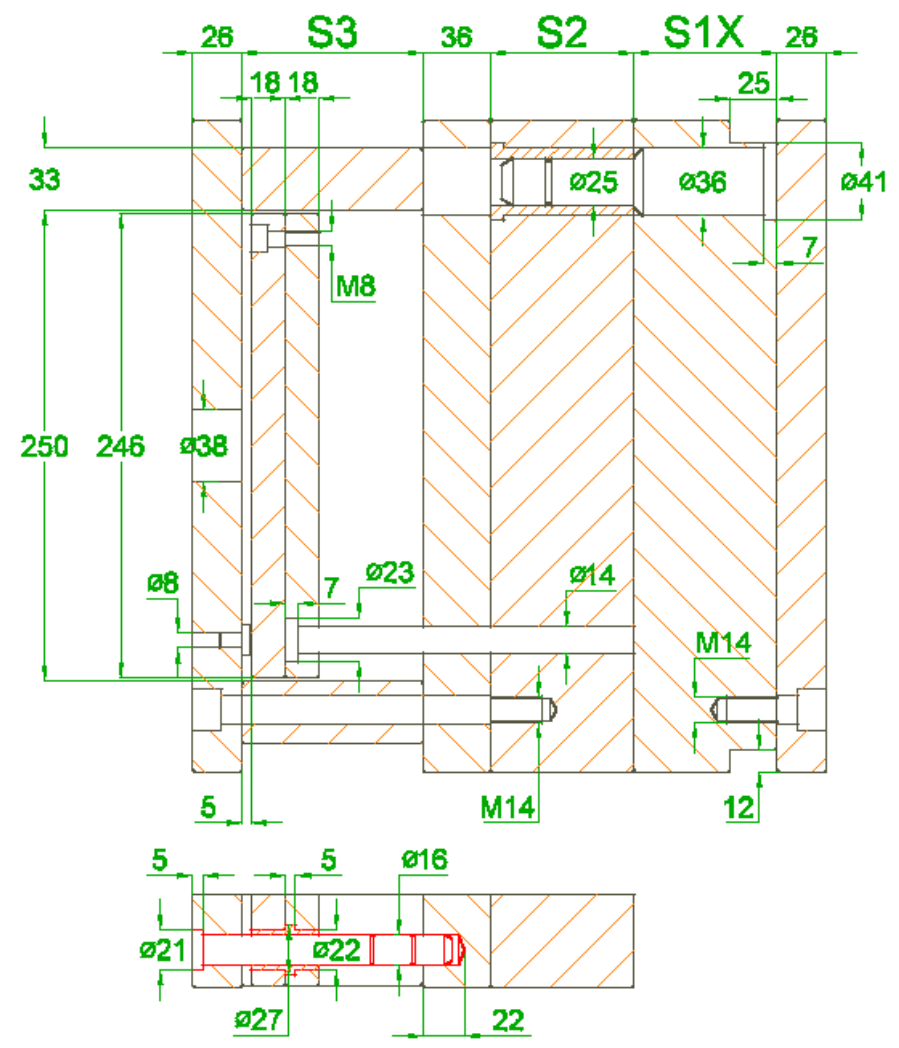
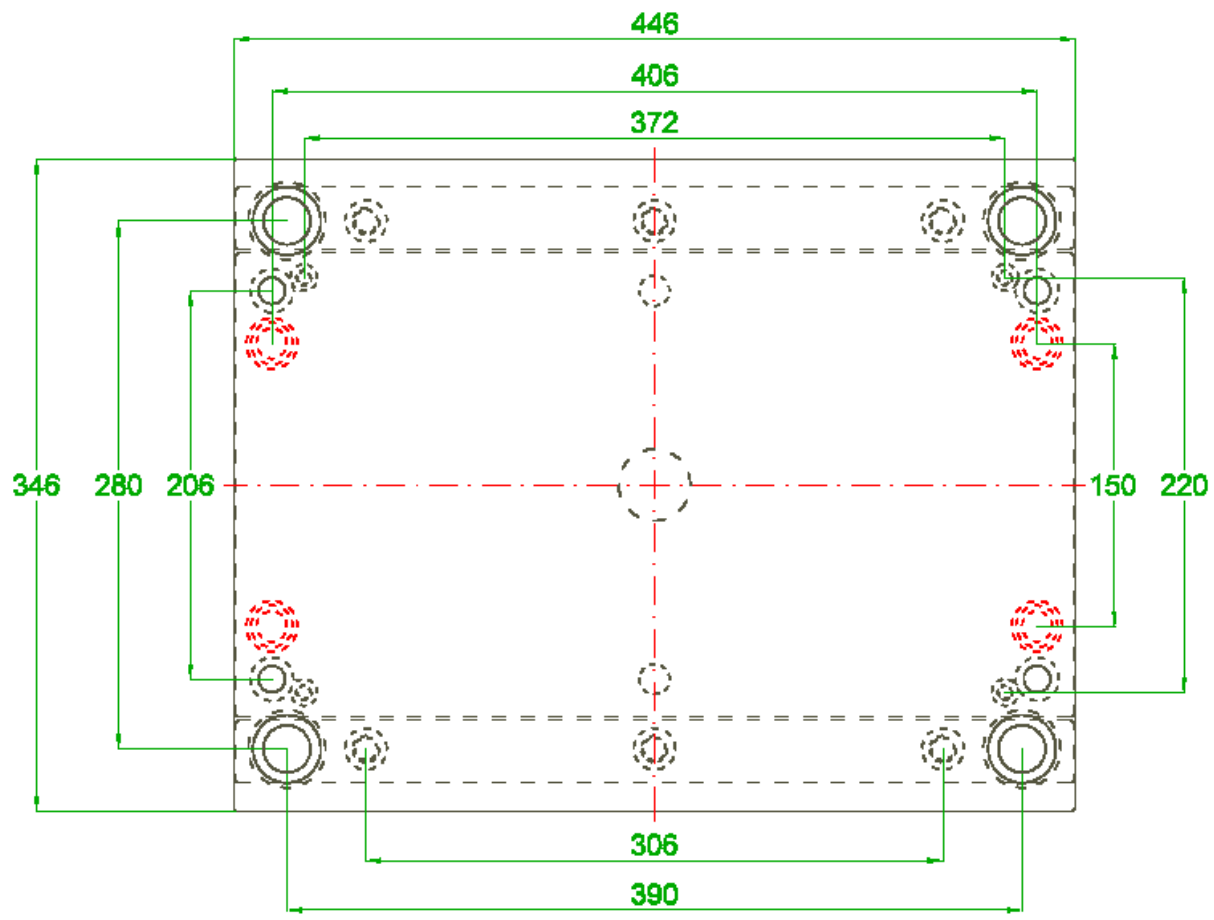

Portastampo serie X 346 x 496

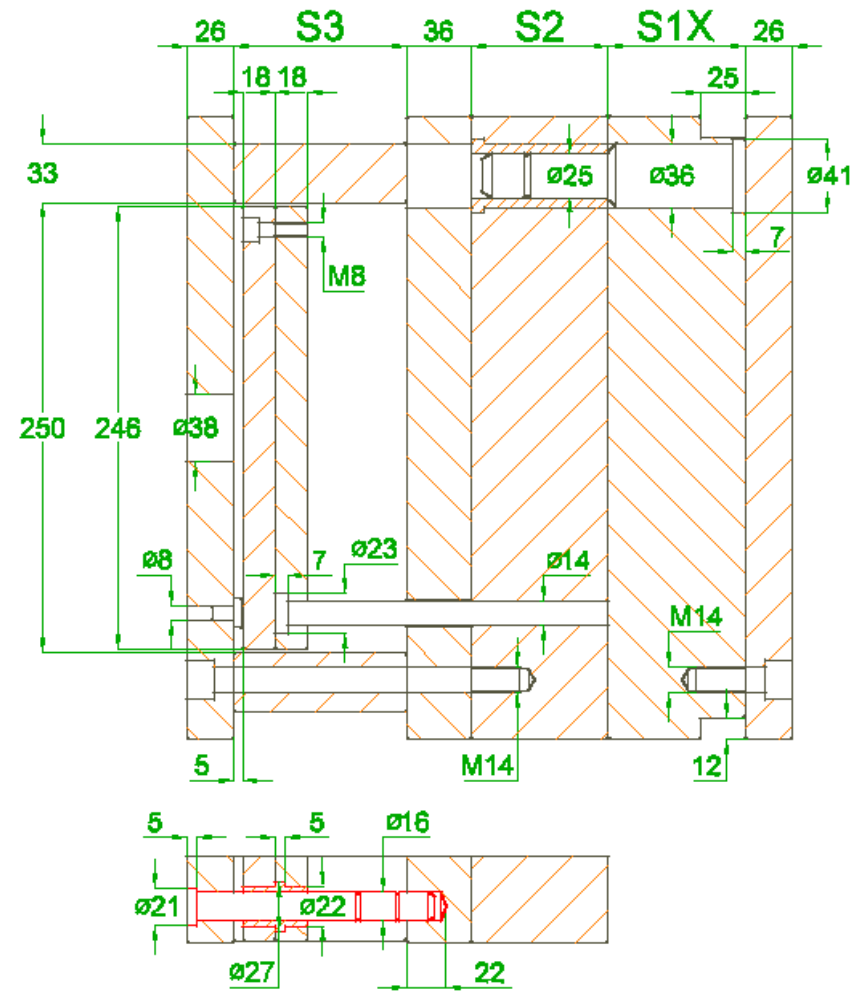
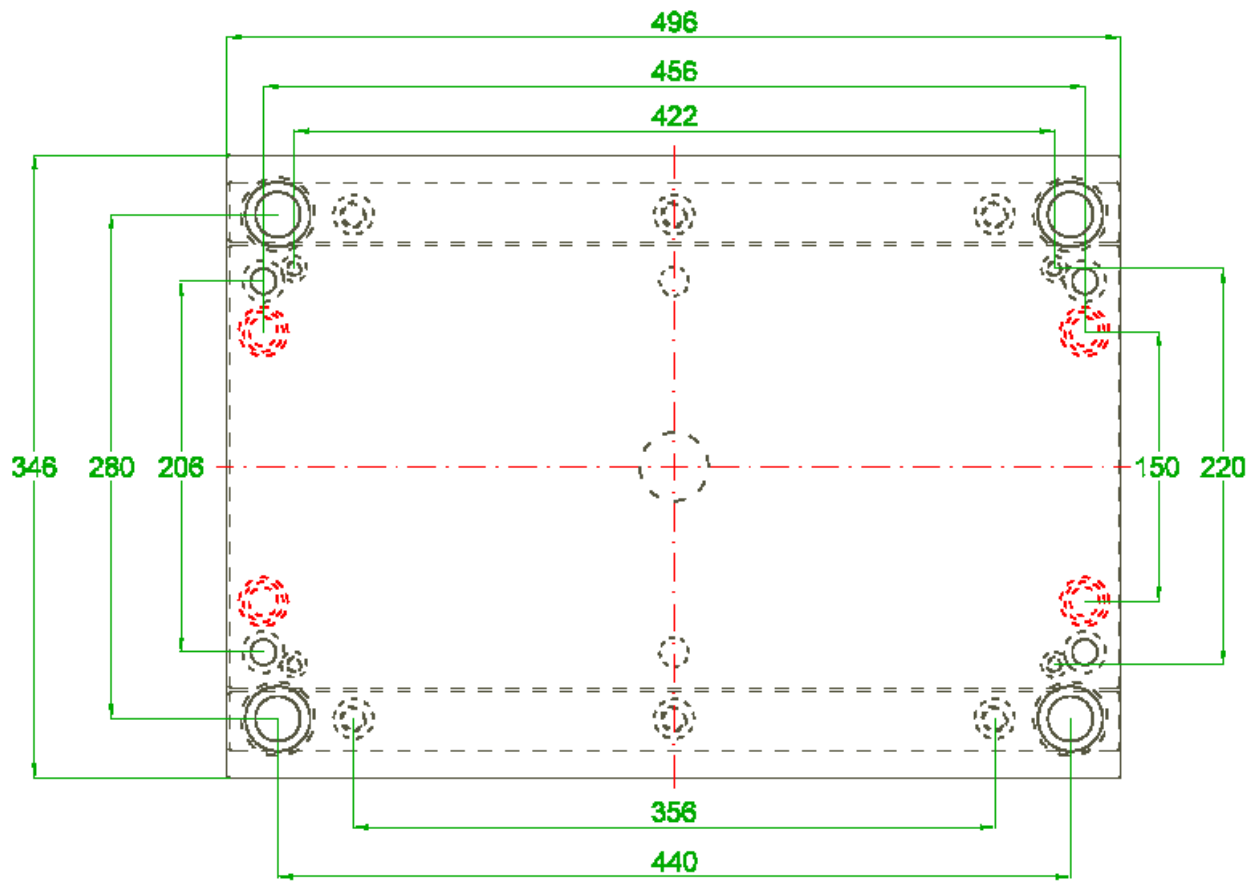

Portastampo serie X 396 x 396

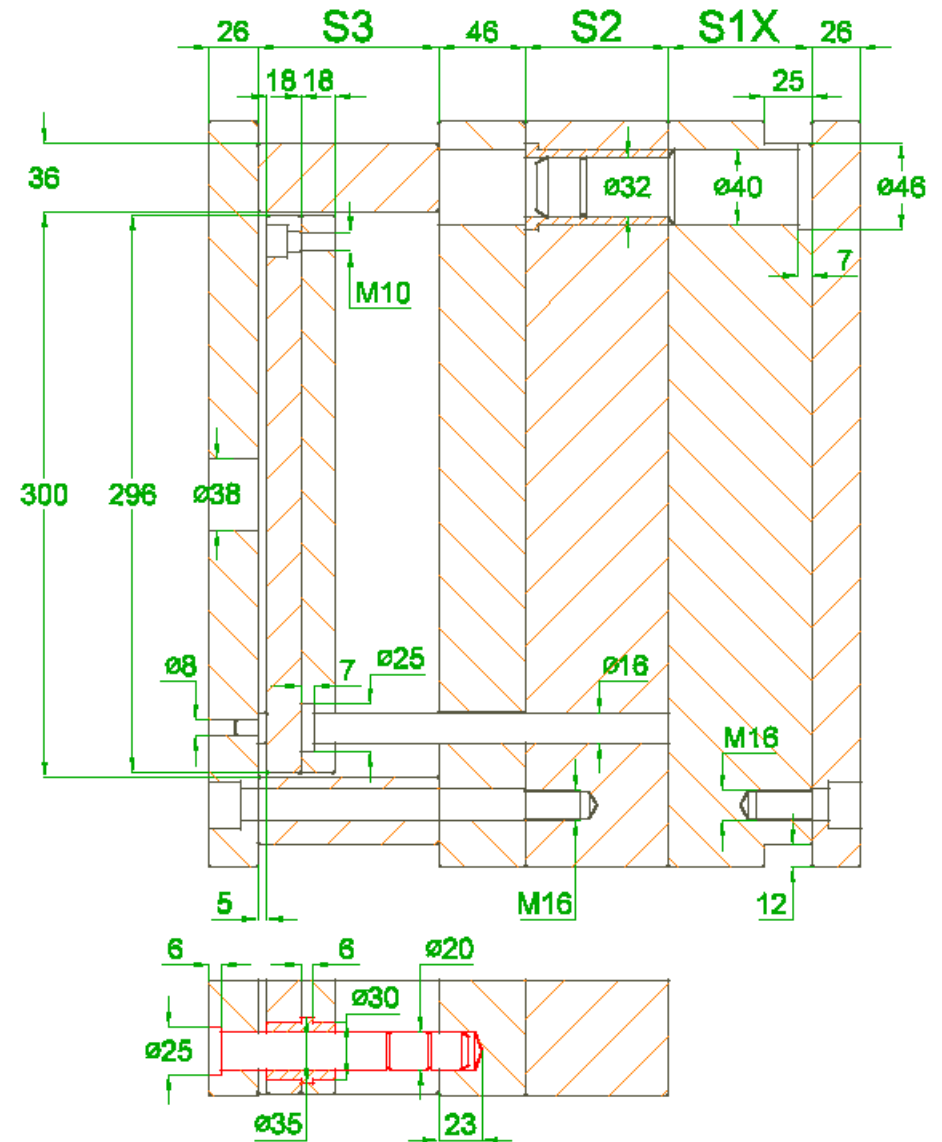
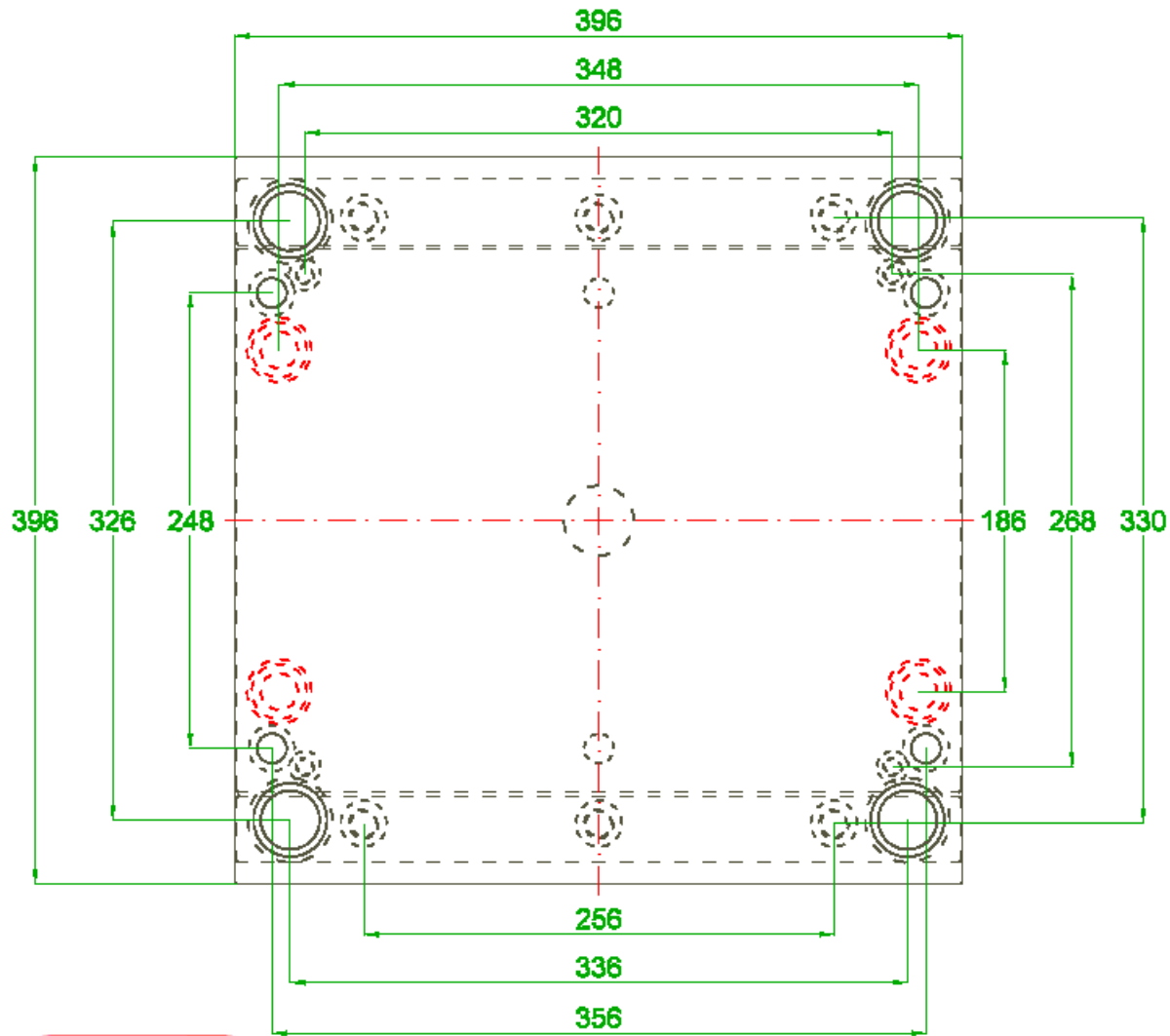

Portastampo serie X 396 x 446

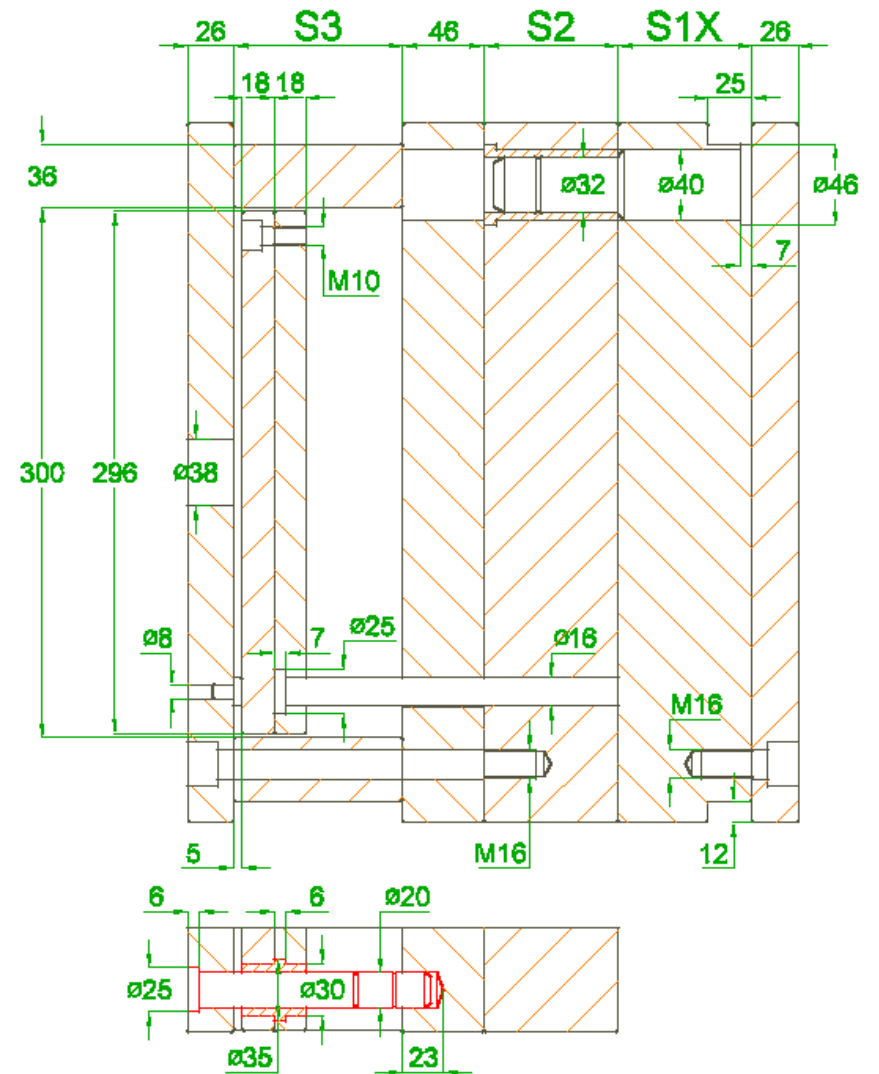
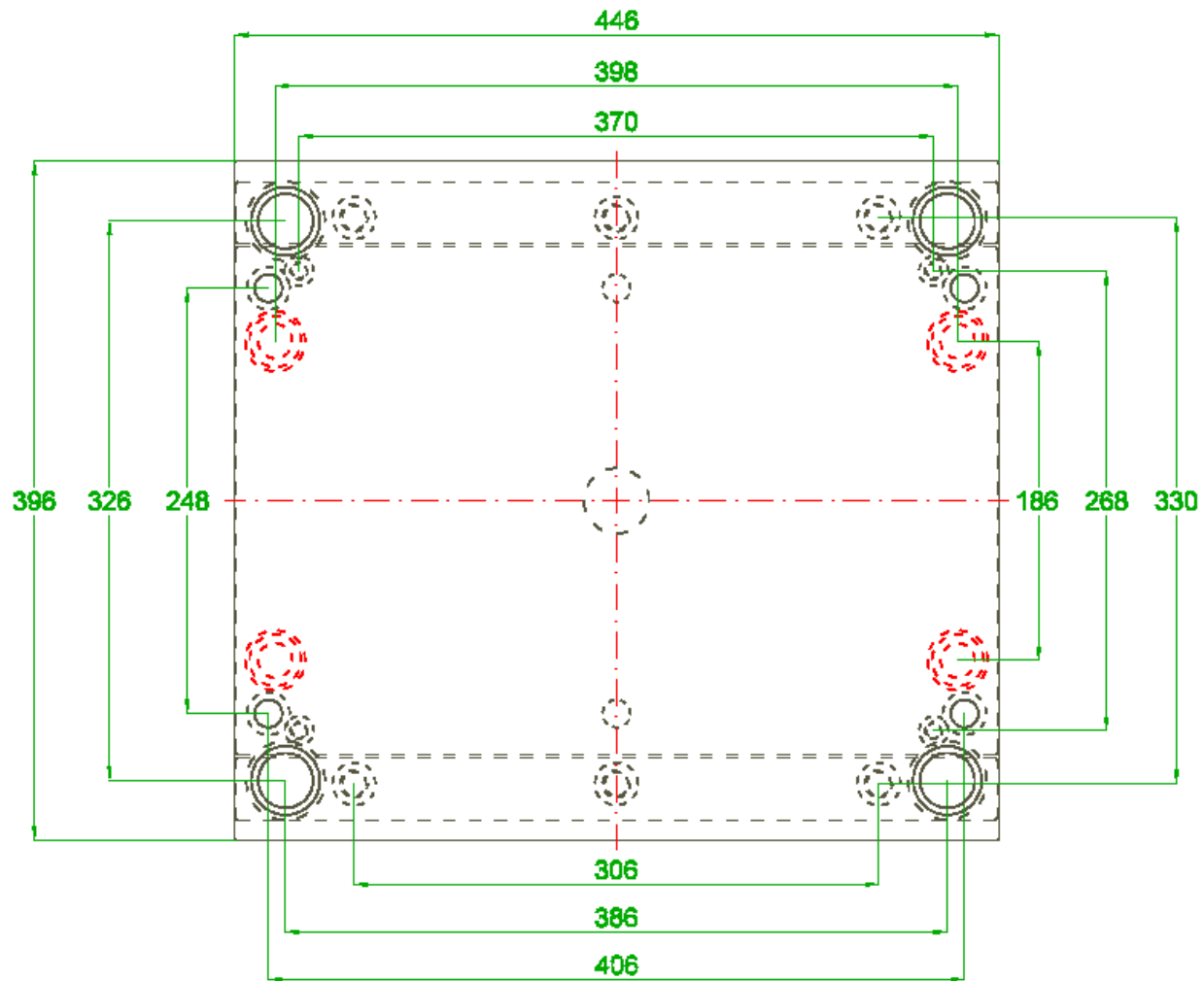

Portastampo serie X 396 x 546

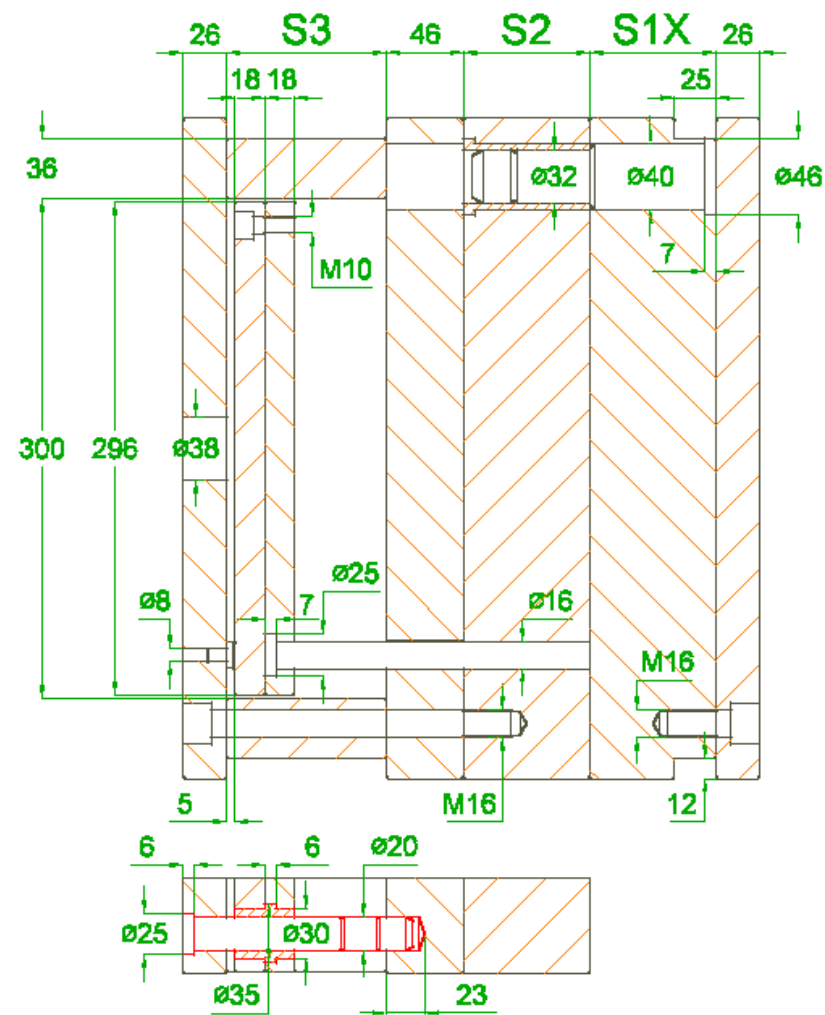
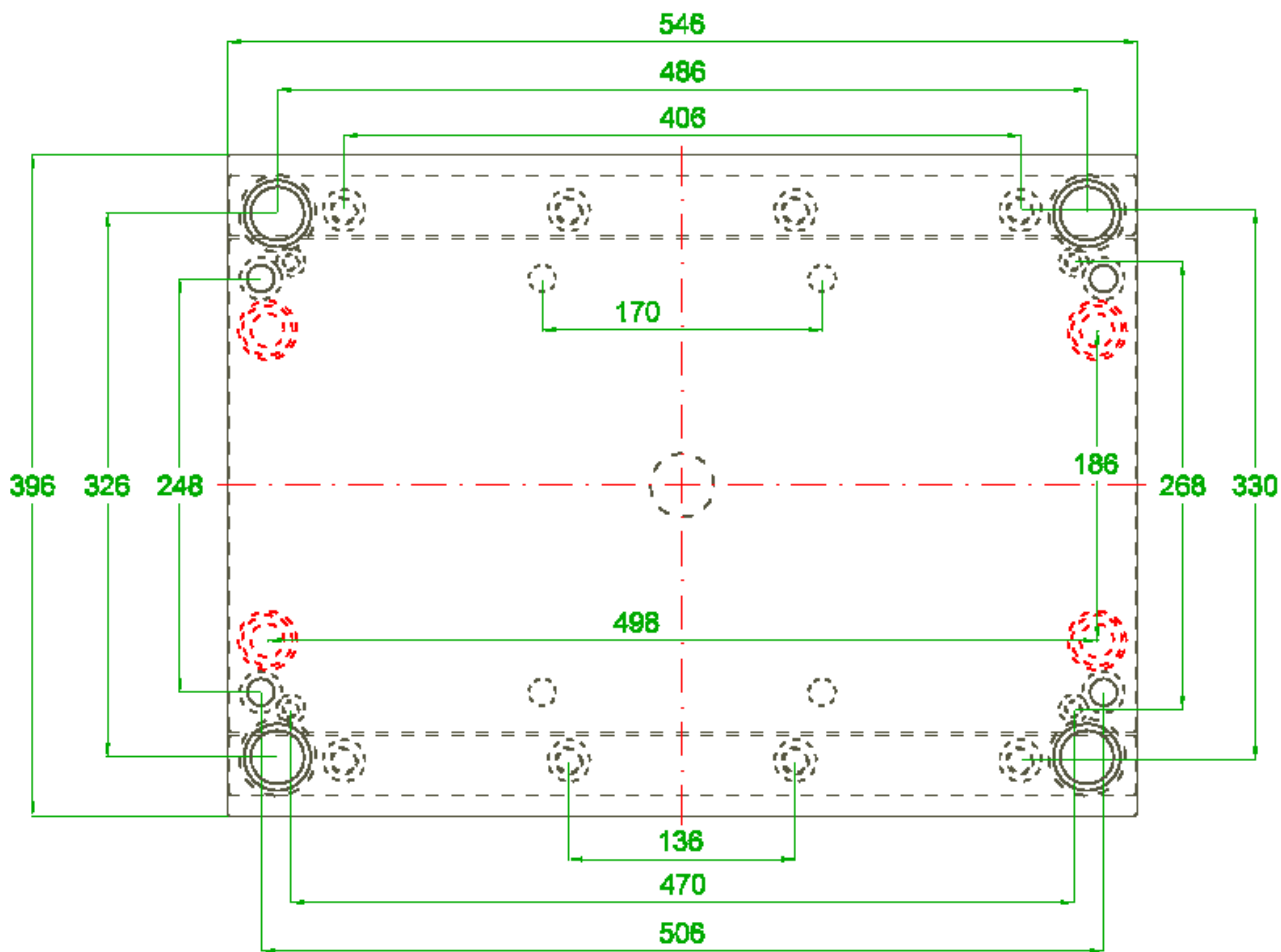

Portastampo serie X 446 x 546

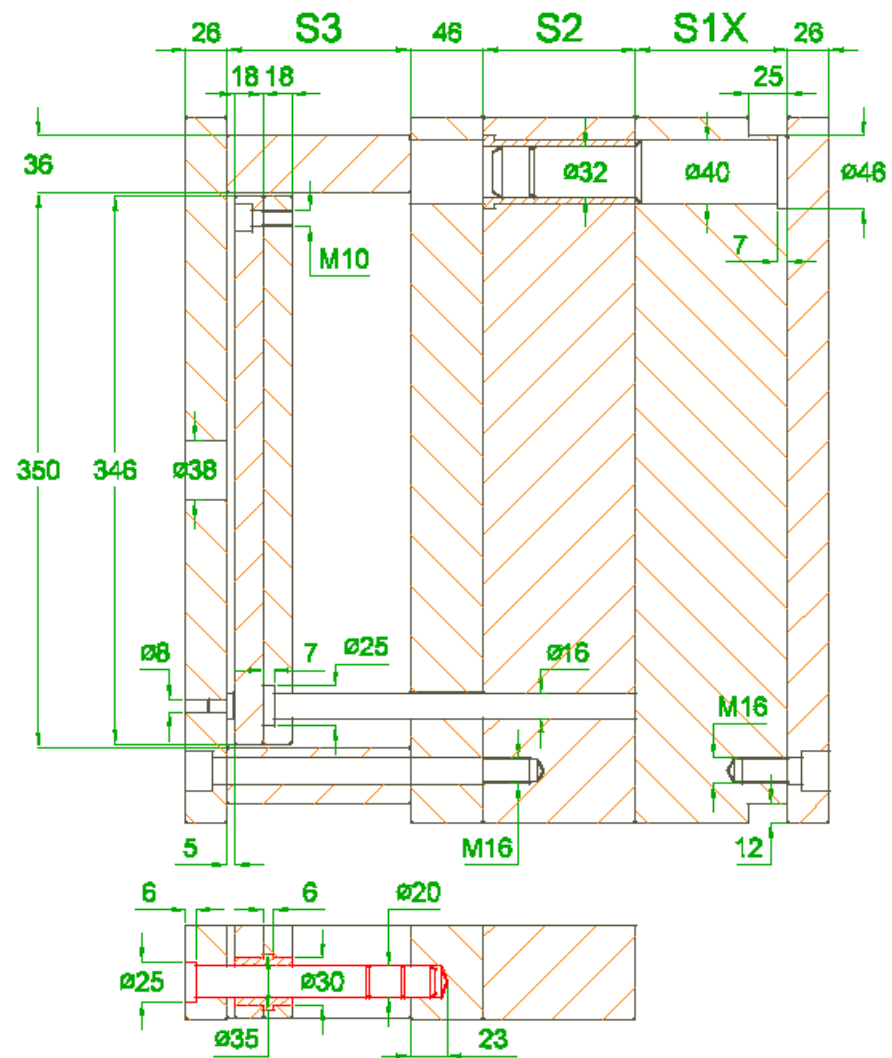
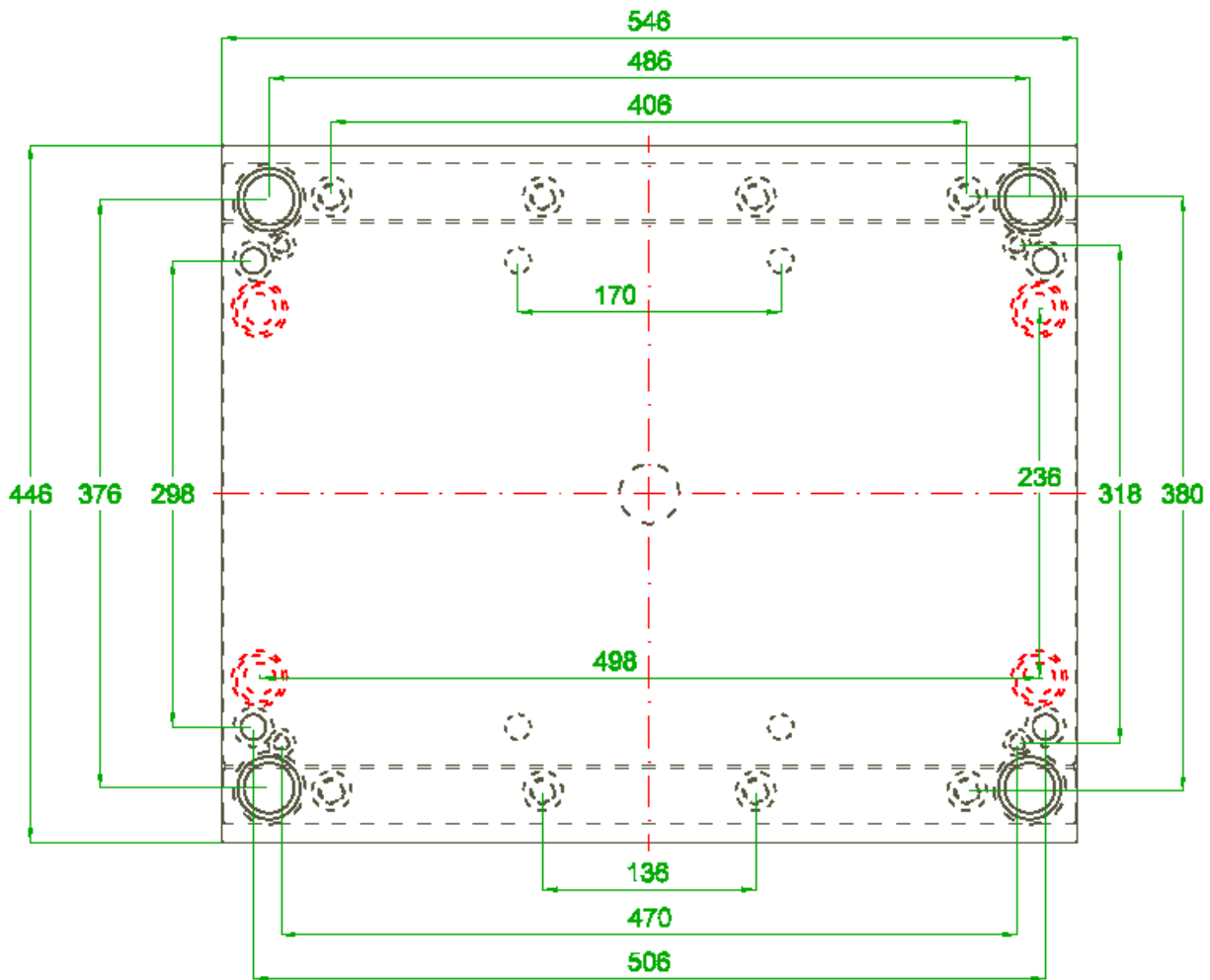

Portastampo serie X 446 x 596

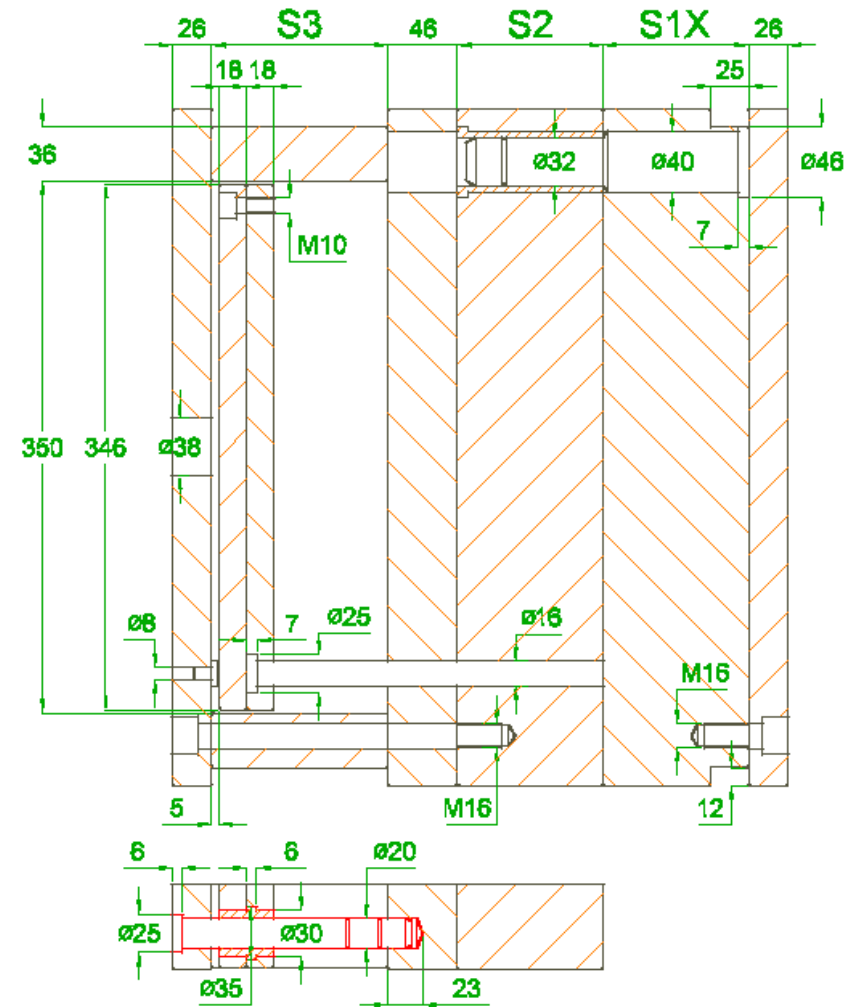
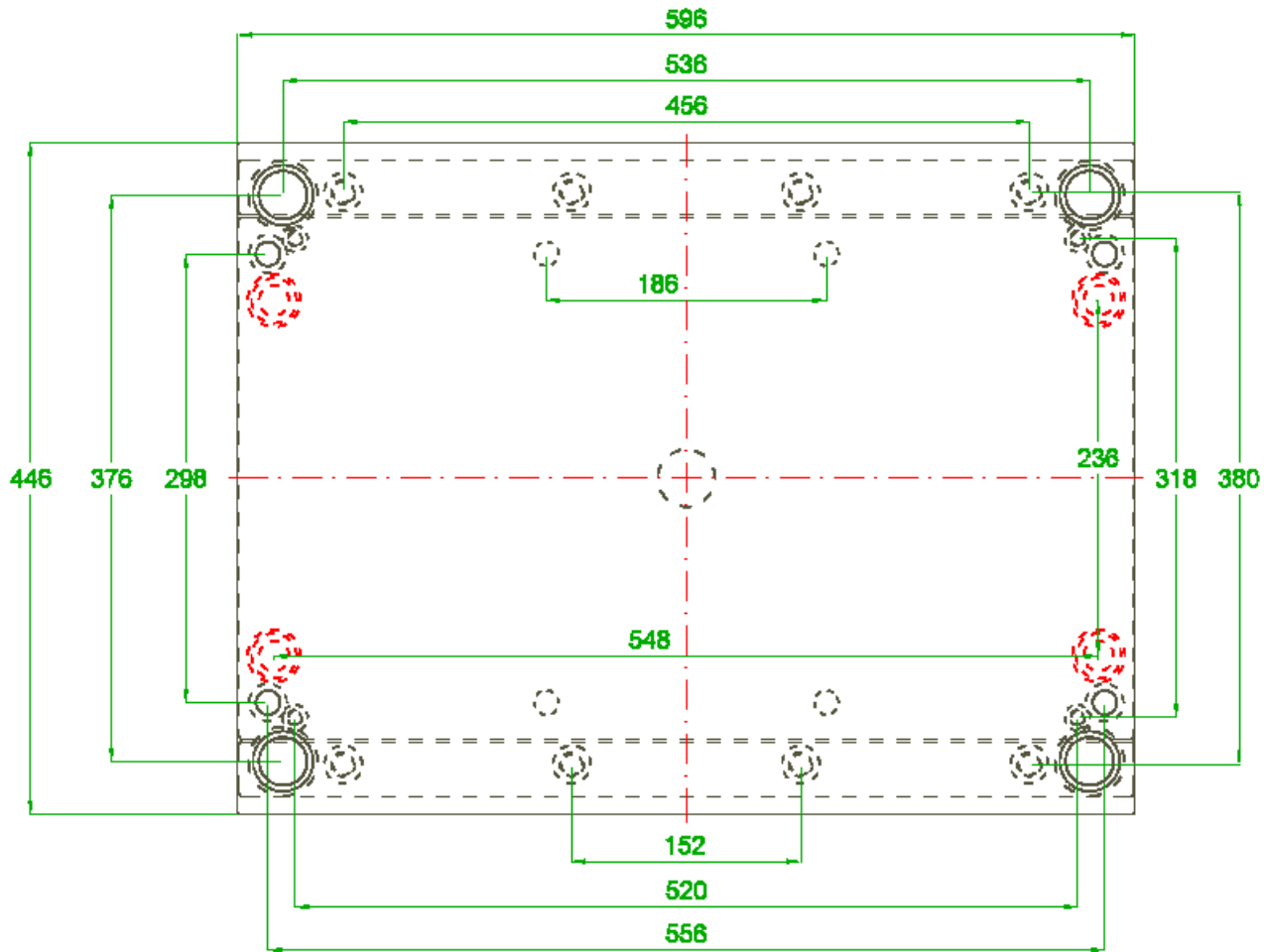

Portastampo serie X 496 x 496

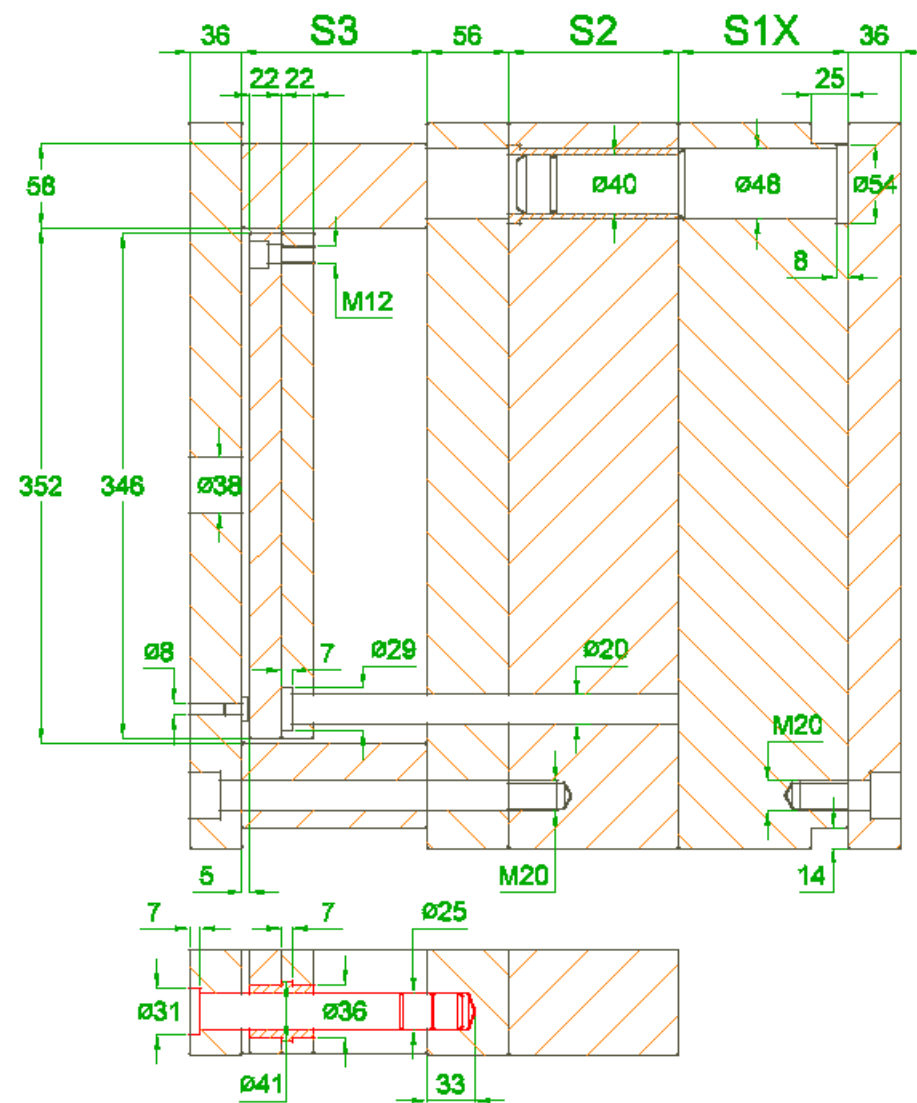
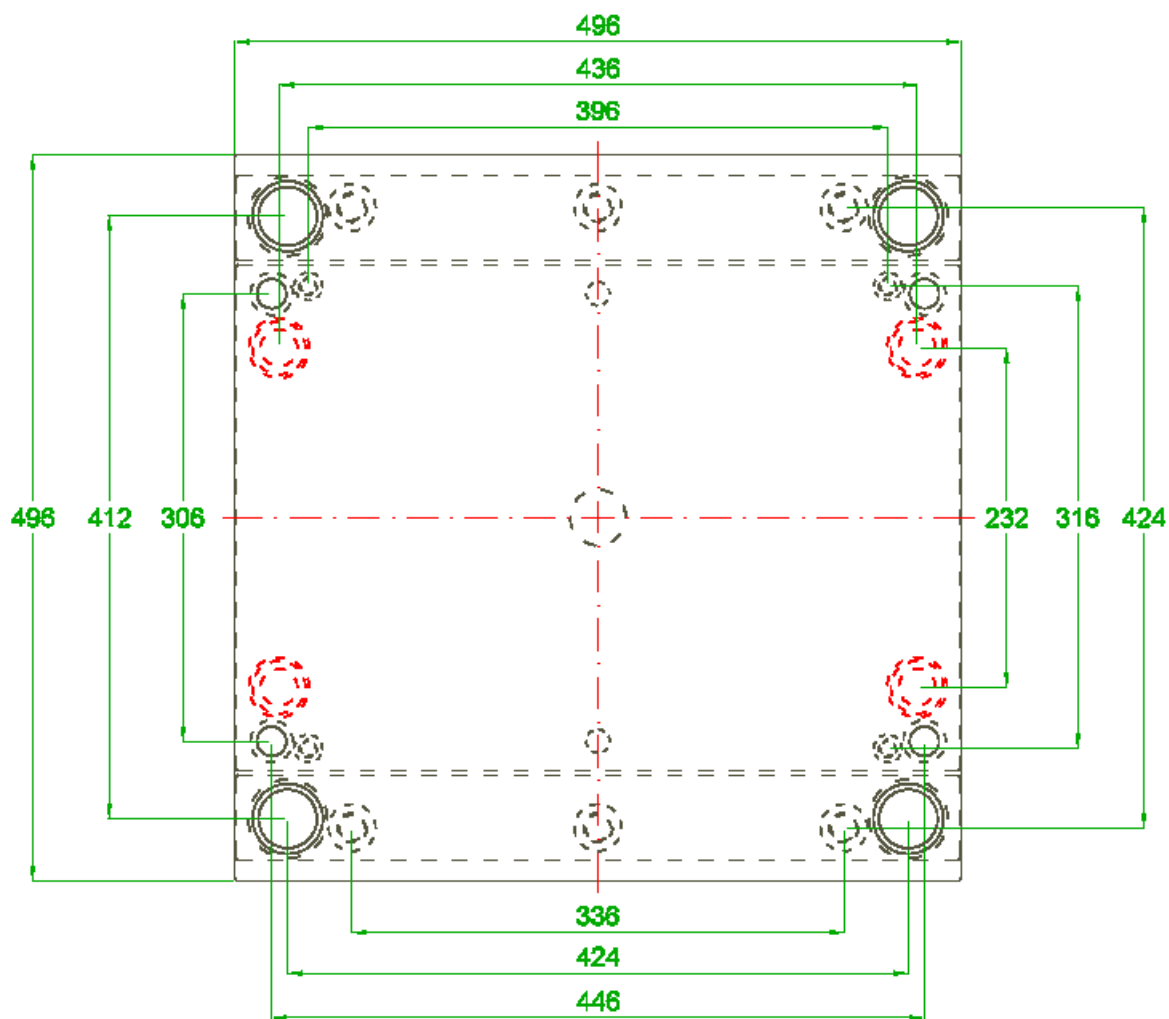

Portastampo serie X 496 x 546

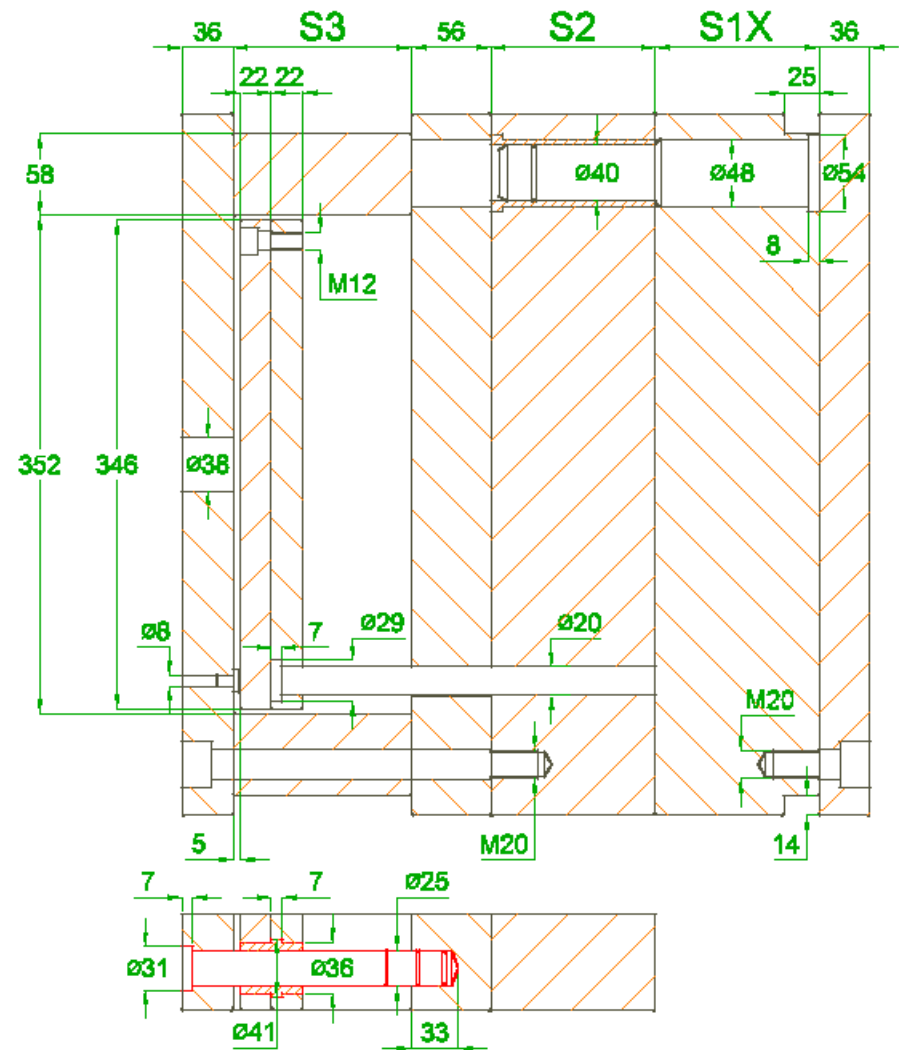
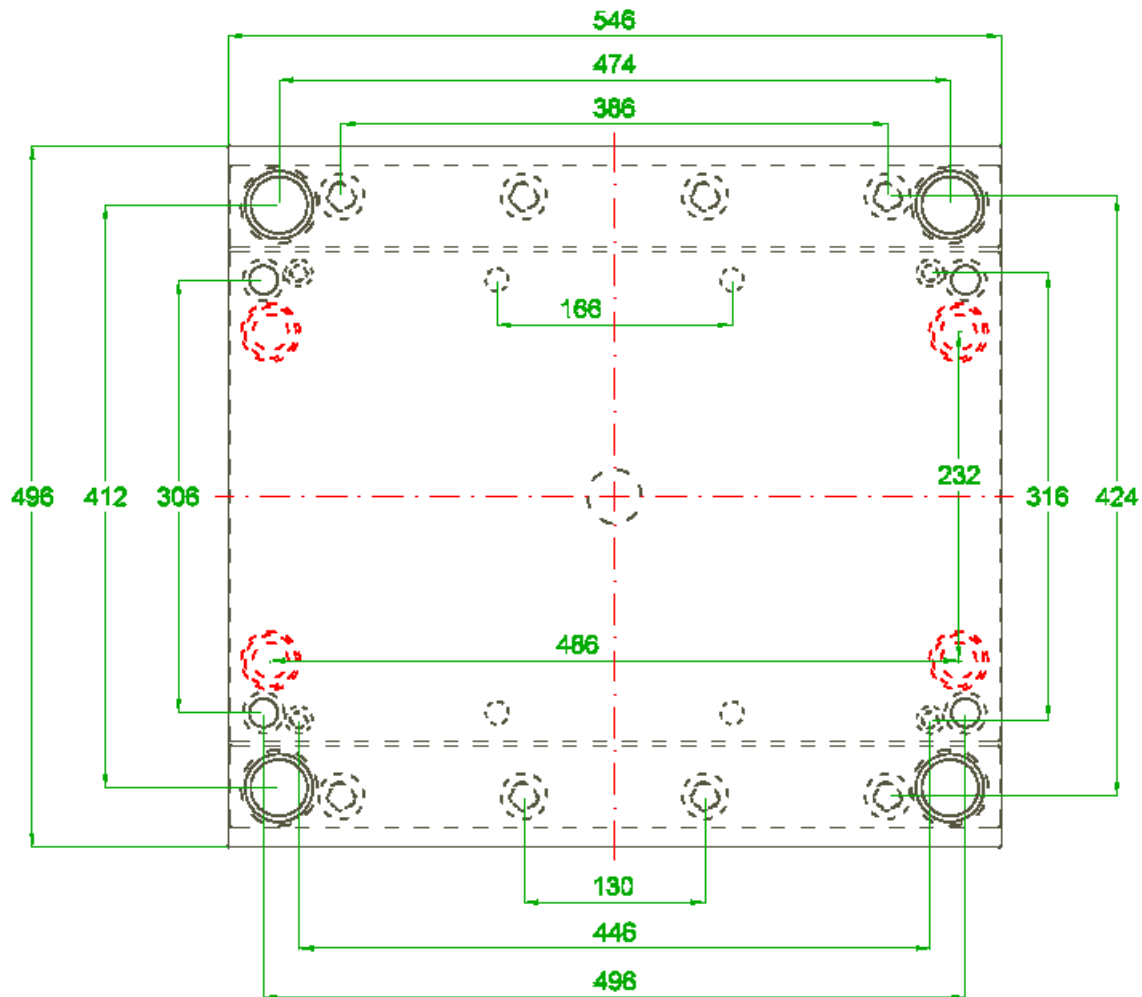

Portastampo serie X 496 x 596

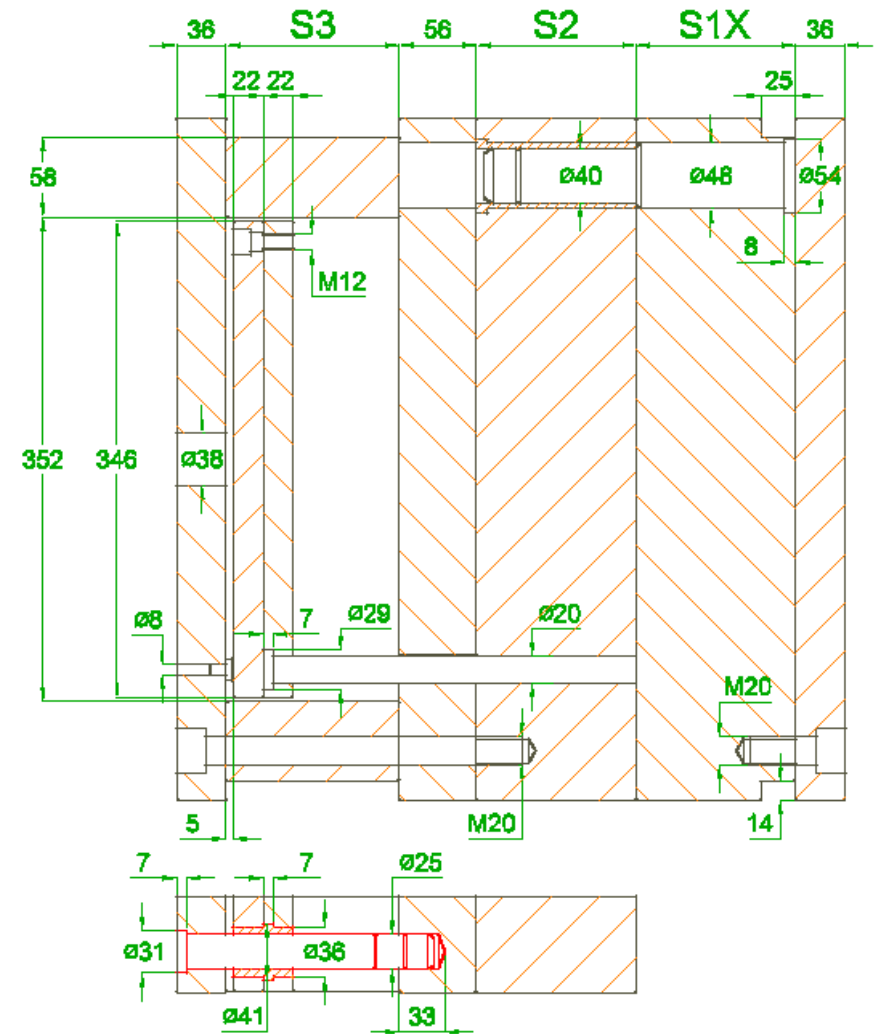
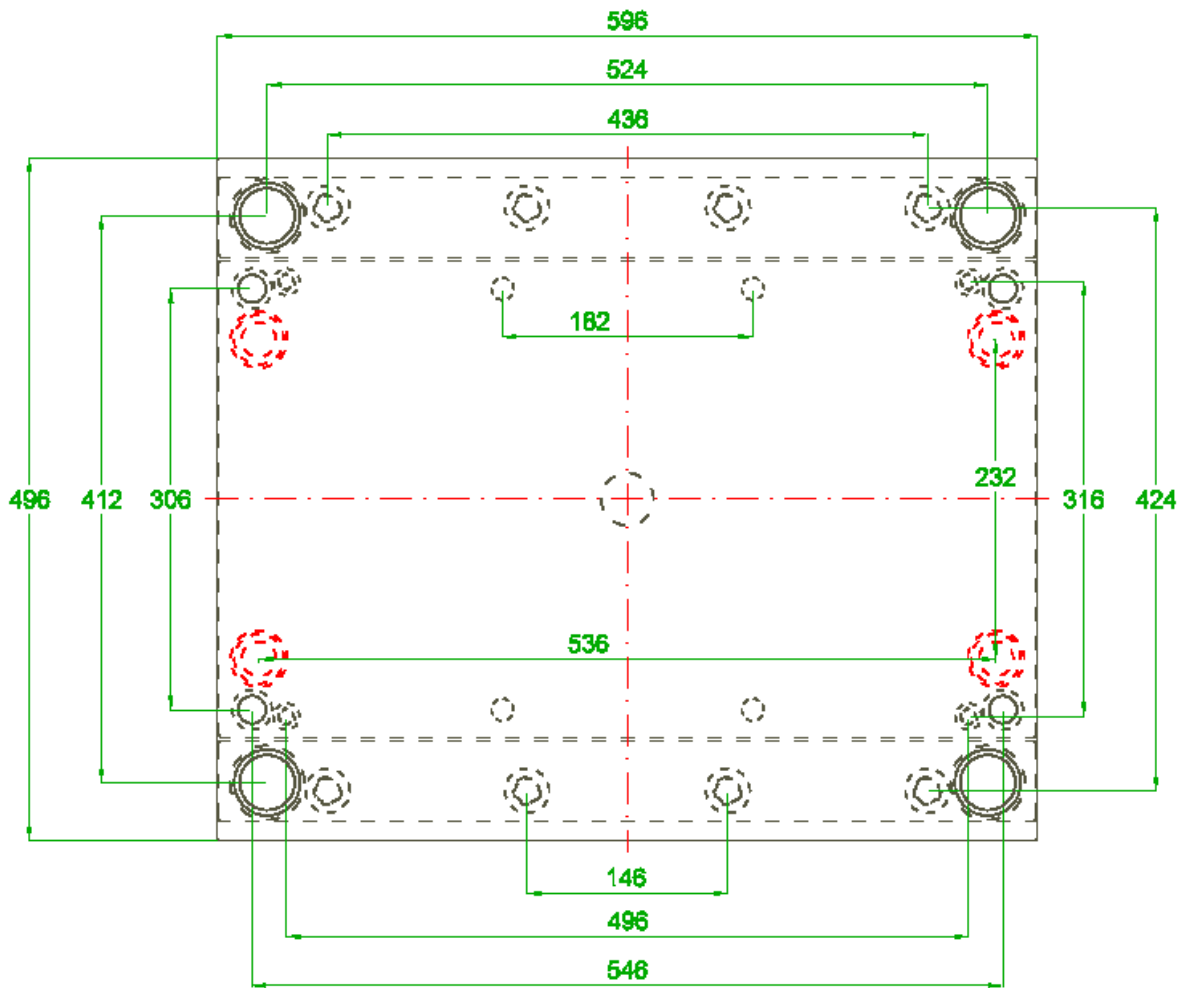

Portastampo serie X 496 x 646

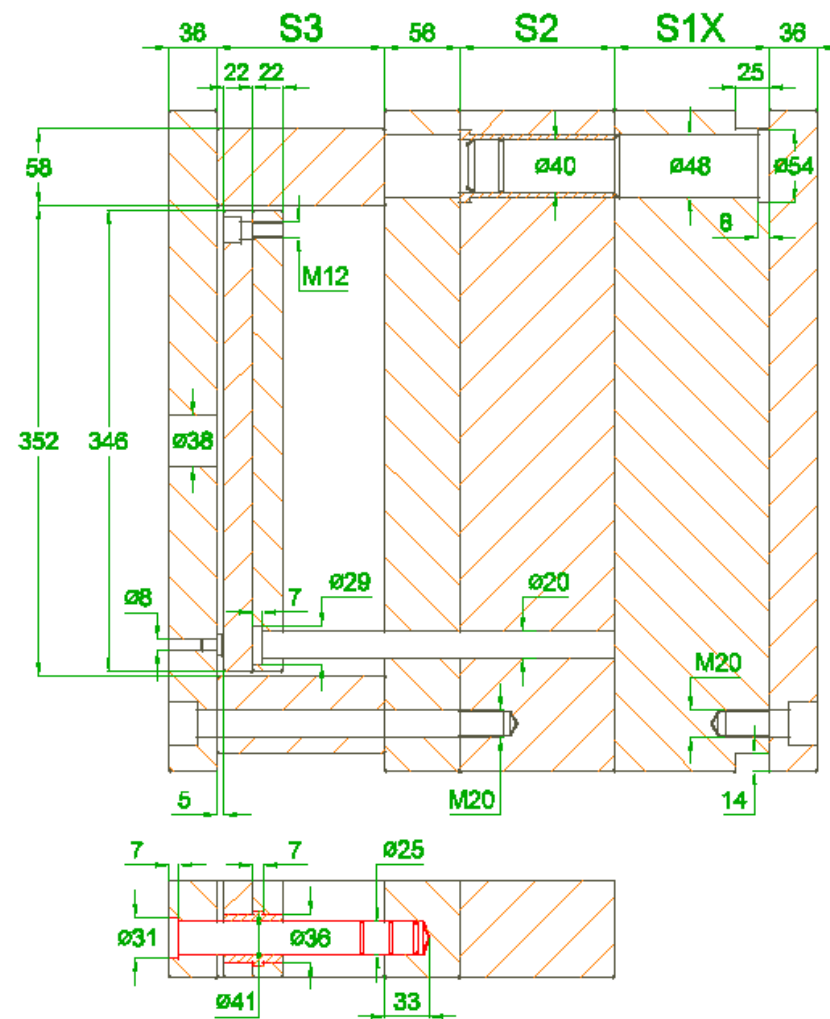
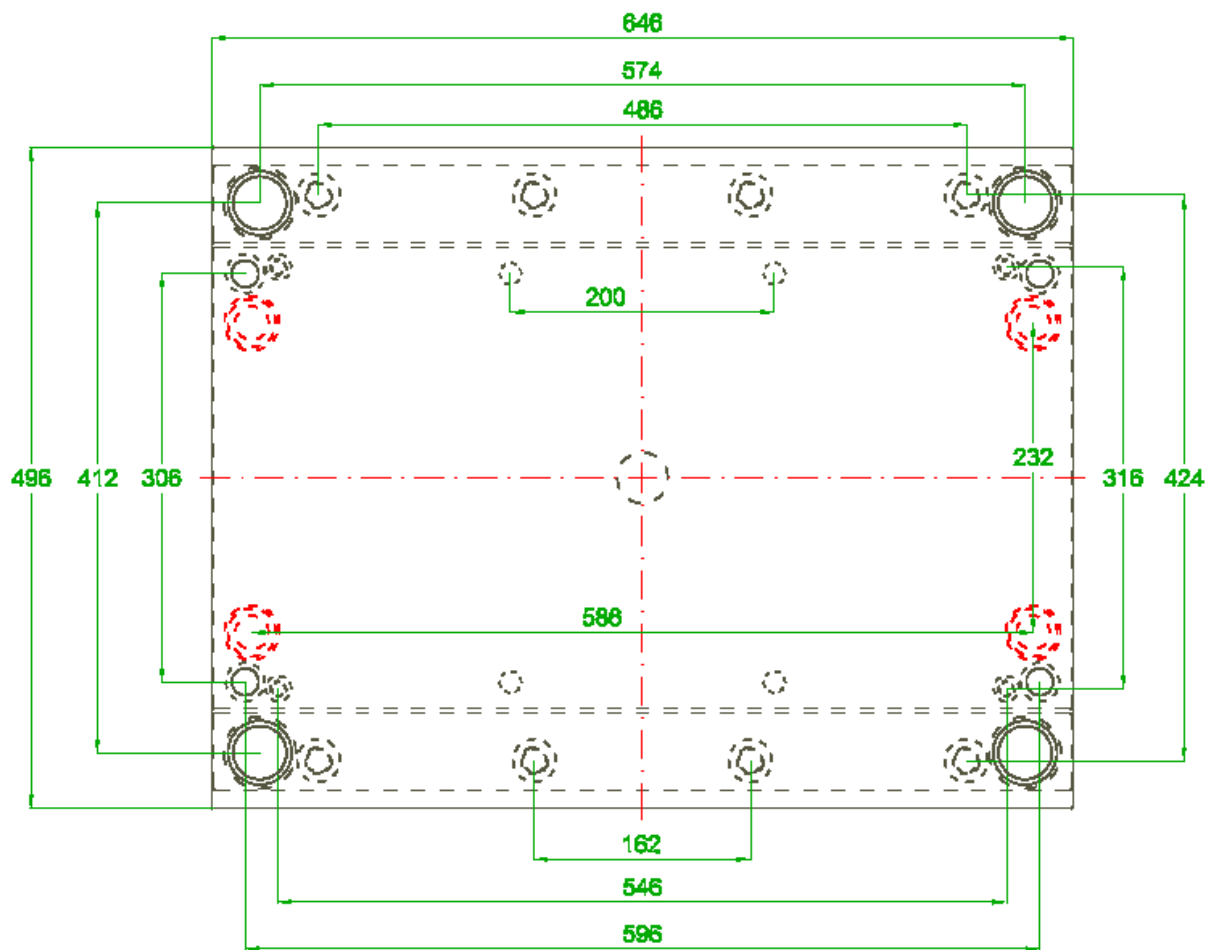

Portastampo serie X + anello di centraggio e ugello

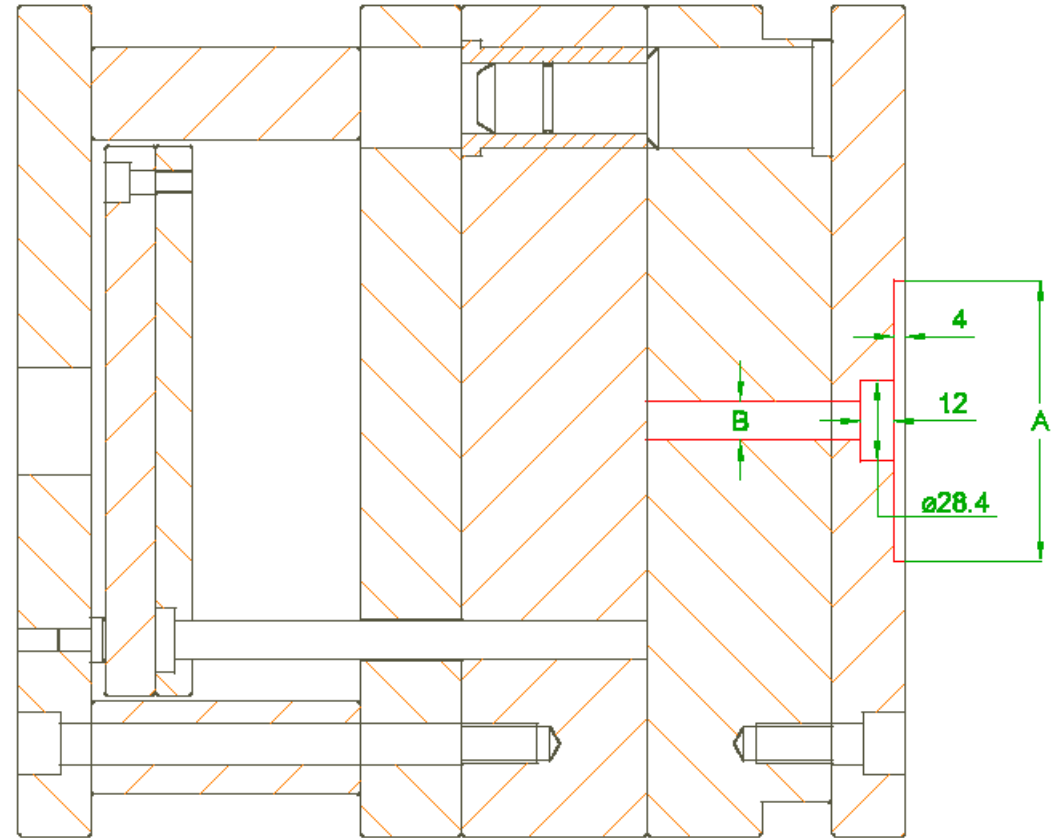
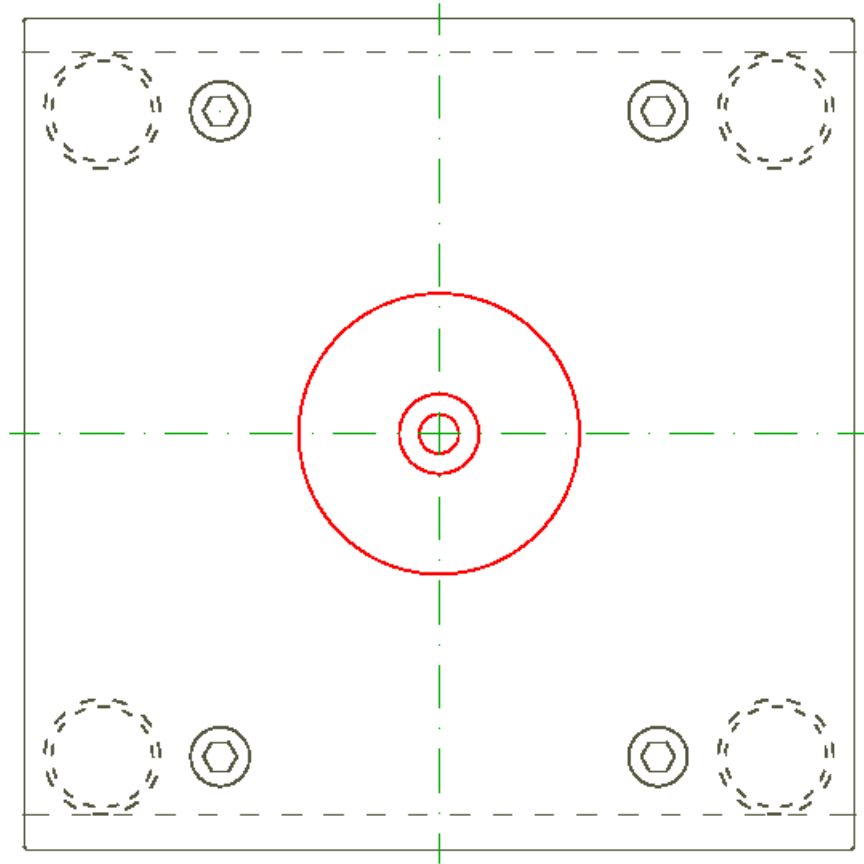

Portastampo serie X + M

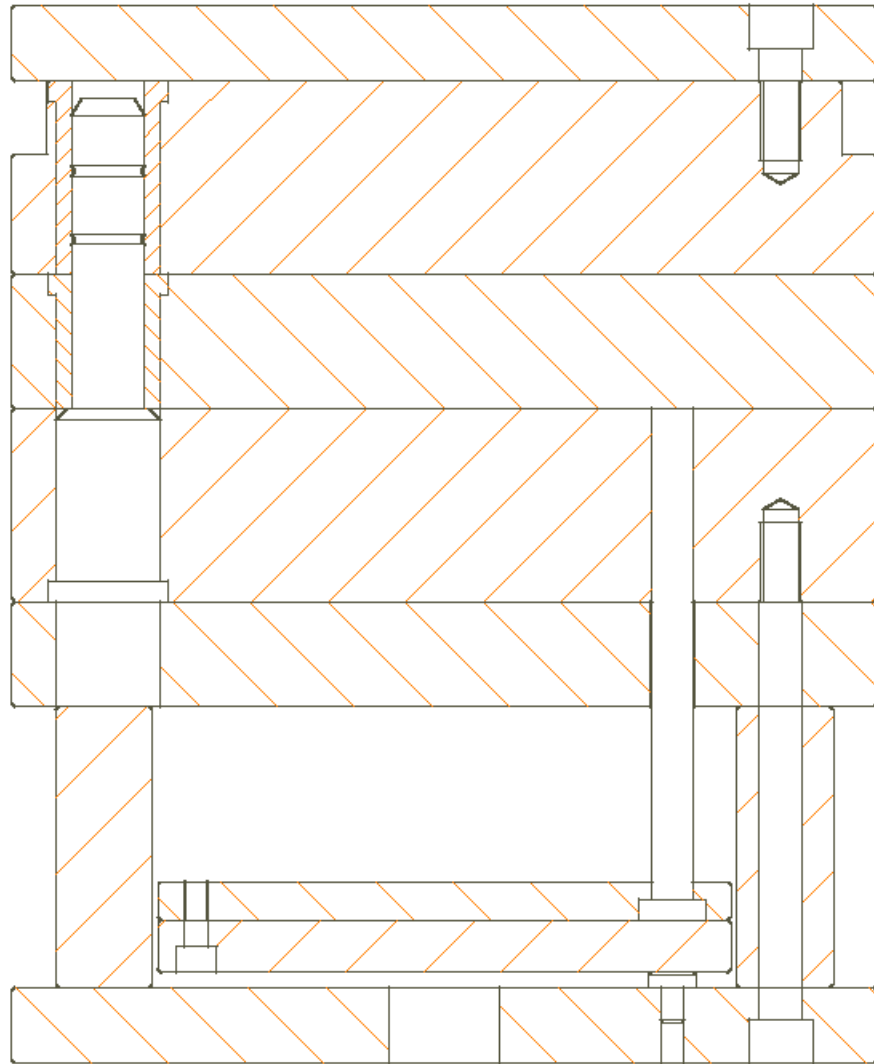

SM

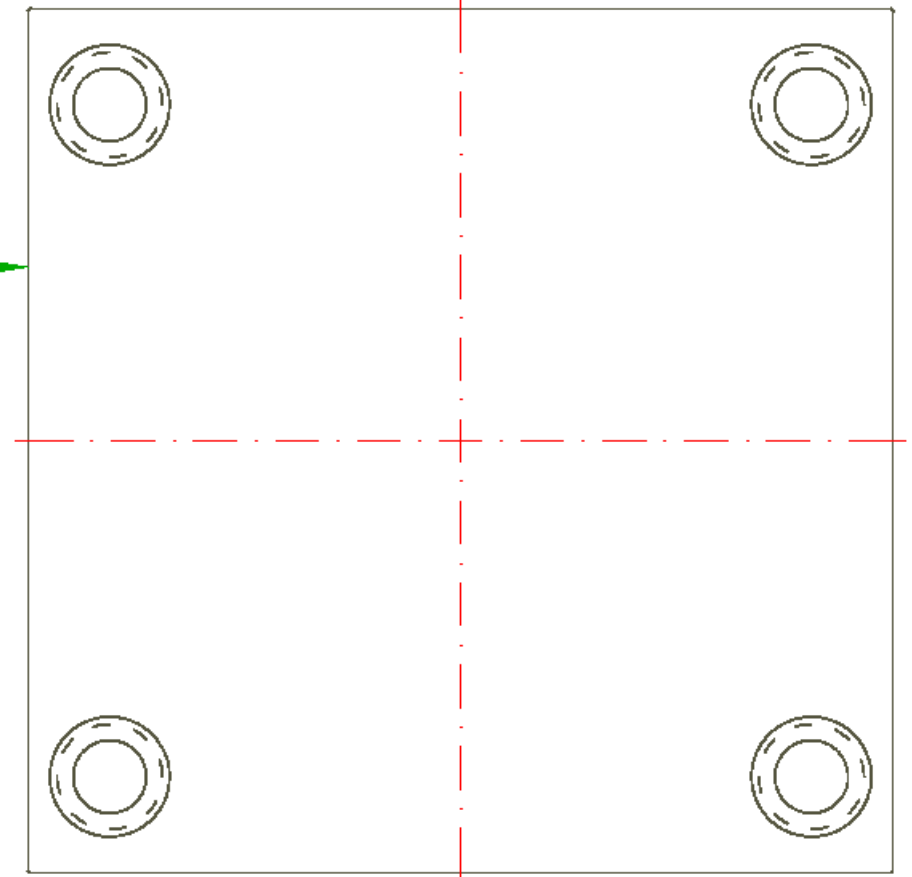

Portastampo serie X + sede molla

